































Circuit Protectors



Circuit Protector Selection Guide

Model		NC1V	NH1S	NH1Y	NH1L (w/indicator)	NH1V
Shape						
		Retractable Actuator	Lever	Rocker	Rocker	Lever
Tripping Method		Hydraulic-magnetic tripping				
No. of Poles		1 to 3 poles	1 to 3 poles (Dual-coil: 1-pole, 2-pole)	1, 2 poles	1, 2 poles	1 to 3 poles
Internal Circuit	Series Trip/Current Trip	Yes	Yes	Yes	Yes	Yes
	Relay Trip/Voltage Trip	Yes	Yes	Yes	Yes	Yes
	Dual-coil	-	Yes	-	-	-
Rating	Rated Voltage	250V AC, 50/60 Hz 65 to 125V DC (3 types are for AC only)	250V AC 50/60 Hz, 65V DC			
	Rated Current (Current Trip)	0.1A to 30A	Current trip: 0.5A to 30A Dual-coil: 2A to 15A			
	Trip Voltage (Voltage Trip)	24 to 48V DC	100V AC, 24V DC (Dual-coil: 24V DC, 100V AC)			
	Rated Interrupting Current	250V AC/2500A 65 to 125V DC/2500A	250V AC/65V DC 1000A (UL/CSA rating), 220V AC 50/60Hz 1000A ()			
Time Delay Curves		3 types	2 types for DC, 3 types for AC			
Auxiliary Contacts/Alarm Contacts		Yes	With	With auxiliary contact	With auxiliary contact	With
Inertia Delay		Yes	With	With	With	With
Mounting Style		Screw mounting, DIN35mm Rail	Panel cut-out (Screw mounting)	Panel cut-out (Snap-on mounting)		DIN rail mounting, Surface mounting
Dimensions (H × W × D mm, 1-pole)		78.8 × 17.5 × 72.6	42 × 16 × 45	55 × 22 × 60		58.7 × 16 × 56
Certification		UL, CSA, TUV, CE,  	UL, c-UL, VDE,  	UL, c-UL, VDE, CE,  	UL, c-UL, VDE, CE,  	UL, c-UL, VDE, CE,  
Page		5	16	16	16	16

Note: See the following pages for further information about the certified products.









Model		NRLT	NRLY	NRLY (w/indicator)	NRLR	NRLR (w/indicator)
Shape						
		Lever	Rocker	(LED/Neon) Rocker	Rocker	(LED/Neon) Rocker
Tripping Method		Hydraulic-magnetic tripping				
No. of Poles		1, 2 poles (1-lever)	1, 2 poles (1-rocker)	1, 2 poles (1-rocker)	1, 2 poles (1-rocker)	1, 2 poles (1-rocker)
Internal Circuit	Series Trip/Current Trip	Yes	Yes	Yes	Yes	Yes
	Relay Trip/Voltage Trip	Yes	Yes	Yes	Yes	Yes
	Switch Type	Yes	Yes	Yes	Yes	Yes
Rating	Rated Voltage	250V AC 50/60Hz, 50V DC				
	Rated Current (Current Trip)	0.5A to 20A		Current trip: For 0.5A to 20A		
	Trip Voltage (Voltage Trip)	100V AC, 24V DC				
	Rated Interrupting Current	250V AC/750A (UL rating: 1000A), 50V DC/500A (UL rating: 1000A)				
Time Delay Curves		3 types for DC, 3 types for AC				
Auxiliary Contacts/Alarm Contacts		With auxiliary contact	With auxiliary contact	With auxiliary contact	With auxiliary contact	With auxiliary contact
Inertia Delay		With	With	With	With	With
Mounting Style		Panel cut-out (Ring mounting)	Panel cut-out (Snap-on mounting)	Panel cut-out (Snap-on mounting)	Panel cut-out (Screw mounting)	Panel cut-out (Screw mounting)
Dimensions (H × W × D mm, 1-pole)		36.6 × 16.8 × 42	50.8 × 22 × 46	50.8 × 22 × 46	44 × 16.8 × 46	44 × 16.8 × 46
Certification		UL, CSA, VDE, CE,  	UL, CSA, VDE, CE,  	UL, CSA, VDE, CE,  	UL, CSA, VDE, CE,  	UL, CSA, VDE, CE,  
Page		40	40	40	40	40



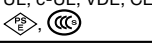

Note: See the following pages for further information about the certified products.

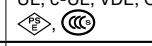
* Protectors indicated with  are for the relay trip type.

Also, the series trip and relay trip types of NRL series are excluded from .

Circuit Protector Selection Guide

NRAS	NRAN	NRAR	NRAR (w/indicator)
			 
Lever	Lever	Rocker	(LED) Rocker (Neon Lamp) Rocker
Hydraulic-magnetic tripping			
1 to 3 poles	1 to 3 poles	1 pole	1 pole
Yes	Yes	Yes	Yes
Yes	Yes	-	-
-	-	-	-
250V AC 50/60 Hz, 65V DC			
0.3A to 30A 24V DC			
250V AC/65V DC, 1000A			
2 types for DC, 3 types for AC			
With	With	With	With
With	With	With	With
Panel cut-out (Screw mounting, snap-on mounting), Surface mounting (Plug-in base), DIN rail mounting (Width: 35 mm)			Panel cut-out (Screw mounting), Panel cut-out (Snap-on mounting)
50.7 × 19.1 × 54.5	50.7 × 19.1 × 50.5	52 × 19 × 65.5	52 × 19 × 65.5
UL, c-UL, VDE, CE, 	UL, c-UL, VDE, CE, 	UL, c-UL, VDE, CE, 	UL, c-UL, VDE, CE, 
28	28	28	28

NRLK	NRLP	NRBM
		
Large Rocker	Lever	Lever
Hydraulic-magnetic tripping		
1, 2 poles (1-rocker)	1 pole	1 to 3 poles
Yes	Yes	Yes
Yes	-	-
Yes	-	-
250V AC 50/60Hz, 50V DC		250V AC, 50/60Hz, 65V DC
Current trip: For 0.5A to 20A	0.5A to 20A	1A to 50A
100V AC, 24V DC	100V AC, 24V DC	-
250V AC/750A (UL rating: 1000A), 50V DC/500A (UL rating: 1000A)		250V AC/65V DC 1000A
3 types for DC, 3 types for AC		2 types for DC, 3 types for AC
With auxiliary contact	With auxiliary contact	With
With	With	With
Panel cut-out (Screw mounting)	PC board	Panel cut-out (Screw mounting)
44 × 16.8 × 44	36.6 × 16.8 × 46	63 × 19.1 × 63.5
UL, CSA, VDE, CE, 	UL, CSA, VDE, CE, 	UL, c-UL, VDE, CE, 
40	40	52

Note: UL and CSA ratings may differ. See the following pages for details.

(Continued on the next page)

Circuit Protector Selection Guide

Series	NRF1	NRF2	NRPS	NRPF
Shape		With manual OFF mechanism 	Slim 	Flat
Tripping method	Thermal tripping			
No. of Poles	1 pole		1 pole (SPST-NC, SPDT)	
Internal Circuit (Current Trip)	Series Trip		Series trip	
Rating	Maximum Circuit Voltage		32V DC, 250V AC	
	Rated Current		300, 500mA 1, 2, 3, 5, 8, 10, 15A	
	Rated Interrupting Current		1A to 4A: Rated current × 10 (resistive load) 5A, 6A: 250V AC/40A, 32V DC/40A (resistive load)	
	Tripping Time		No trip at the rated current Within 1 hour at 135% the rated current	
Reset Time		1 min minimum (at 135% the rated current) (*1)		
Time Delay Curves	1 type		1 type	
Auxiliary Contacts	With		-	
Mounting Style	Panel cut-out (Snap-on mounting)		PC board mounting	
Certification	UL, CSA, TÜV (*2),		UL, CSA	
Page	56		59	

*1: Reset time is the value at the reference ambient temperature of 25°C.

*2: TÜV certification: for 8A, 10A and 15A only.

Common Description of Circuit Protectors

Internal Circuit Overview and Application Examples

Series Trip	Series Trip with Auxiliary Contacts	Series Trip with Alarm Contacts	Dual-coil
<p>This is the most common circuit protector, providing excellent overload and short circuit protection. It can also be used as ON/OFF switch, except NRF and NRP series.</p>	<p>As the auxiliary contact operation is interlocked with the ON/OFF of the main contactor, circuit protector operation can be monitored by a lamp. The auxiliary contact can also be used to control auxiliary circuits.</p>	<p>The alarm contact is electrically independent of the ON/OFF of the main contactor, but actuates when the protective element operates. Therefore, the alarm contact can be used with a lamp or buzzer to indicate trip operation and control alarm circuits. After the alarm contact has tripped, turn the lever ON to set the alarm contact.</p>	<p>The dual coil circuit protector is provided with both a series trip (current trip) and relay trip (voltage trip). In the following example circuit, Coil A (current coil) performs overload and short circuit protection, while Coil B (voltage coil) serves to shut down the circuit when the alarm contact detects an abnormal condition.</p> <p>Dashed lines show the connection when the voltage is the same as that for the load circuit.</p> <p>Applying time of tripping voltage: Within 1 sec.</p>

Relay Trip/Voltage Trip
The internal structure is identical to the current tripping protector, but the protective element has no time-delay function and the load circuit is cut off by the instantaneous tripping of the protector. Suitable for purposes, such as cutting off the power supply by using the alarm signal of the secondary circuit of the transformer.

• Applications by Time Delay Curve

Time Delay Curves	Applications
Curve AD Curve AA	The most common curves used for circuit breakers.
Curve MD Curve MA	Suited for motor loads that draw high inrush currents lasting for a rather long period of time.
With inertia delay (Inertia delay mechanism)	Suited for transformer and lamp loads that draw steep inrush currents.

Selection Guide

Select an appropriate circuit protector with a required delay curve and rated current in consideration of the characteristics of the circuit or equipment to be protected.

- When starting an inductive load, the inrush current reaches up to over ten times the rated current. Select the rated current to prevent tripping at starting current.

Example
Solenoid rating
Rated current: 0.7A
Inrush current: 3A max.
Inrush time: Approx.0.1 sec

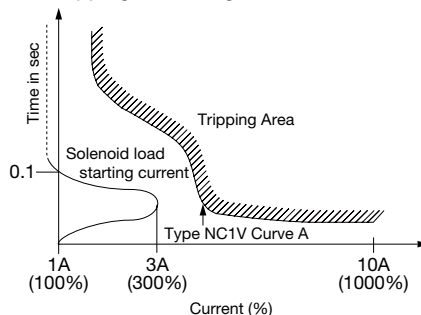

For solenoid protection such as the above example, NC1V circuit protector for the rated current 1A is suited.

- For semiconductor element, the joint-use of short delay fuse for semiconductor protection is more effective.

NC1V Circuit Protectors

IDEC's original spring-up, fingersafe terminals enhance reliability and safety.

- Integrated electric shock protection structure (IP20).
- Auxiliary/alarm contact terminals and voltage coil terminals on the relay trip types are equipped with terminal covers.
- Spring-up, fingersafe terminals reduce wiring time.
- Ring terminals can be installed. Captive terminal screws.
- Available with inertial delay
- Available with auxiliary or alarm contacts
- Rated short-circuit capacity: 2500A
- Slim, space-saving housing
 - 1-pole: 17.5mm wide
 - 2-pole: 35.0mm wide
 - 3-pole: 52.5mm wide
- Retractable actuator
- The trip-free mechanism maintains the circuit open even when the operator is turned on after tripping.



Applicable Standards	Mark	Certification Organization / File No.
UL1077		UL recognized File No. E68029
CSA C22.2 No. 235		CSA file No. LR83454
EN60934		TÜV SÜD
EN60947-2		European Commission's EU Low Voltage Directive
GB17701		CCC No. 2008010307265840
Electrical Appliance and Material Safety Law Technical Standard	Series Trip	
	Relay Trip	

Note: TÜV, CE, and CCC marks are applicable for series trip type only.

Specifications

Operator Style	Retractable actuator		
Internal Circuit	Series trip (current trip), Relay trip (voltage trip)		
Protection Method	Hydraulic magnetic tripping system, Magnetic tripping system (voltage trip)		
No. of Poles	1-pole	2-pole	3-pole
Rated Voltage (AC/DC) (Note 1)	250V AC 50/60Hz, 65V DC	250V AC 50/60Hz, 125V DC	250V AC, 50/60Hz
Series Trip (Current Trip)	Rated Short-circuit Capacity	250V AC, 2500A 65V DC, 2500A	250V AC, 2500A 125V DC, 2500A
	Rated Current	0.1A, 0.3A, 0.5A, 1A, 2A, 3A, 5A, 7A, 10A, 15A, 20A, 25A, 30A	
	Trip Characteristics (Note 2)	Time delay curve curve M (slow), curve A (medium), S (instantaneous) Curves M and A are available with inertial delay.	
Relay Trip (Voltage Trip) (Note 3)	Rated Current	30A	
	Trip Voltage	24 to 48V DC (at 25°C) Voltage application duration 10 sec maximum, tripping time 0.1 sec maximum (at rated voltage)	
Auxiliary Contact/ Alarm Contact	Contact Rating	125V AC 3A (resistive load), 30V DC 2A (resistive load)	
	Minimum Applicable Load	24V DC 1mA (resistive load, reference value)	
Insulation Resistance	100 MΩ minimum (500V DC megger)		
Dielectric Strength	2000V AC, 1 minute (between terminals when main contacts are open, between live parts of different poles, between live and dead parts) 600V AC (between terminals when auxiliary circuits are open)		
Vibration Resistance (with rated current applied)	Damage limits: 147 m/s ² (10 to 55 Hz) (1-pole, 2-pole), 78 m/s ² (3-pole) Operating extremes: 98 m/s ² (1-pole, 2-pole), 78 m/s ² (3-pole)		
Shock Resistance (S time delay curve: 80% rated current, A, M time delay curve: 100% rated current)	Damage limits: 490 m/s ² (1-pole, 2-pole), 297 m/s ² (3-pole) Operating extremes: 196 m/s ²		
Electrical Life	10,000 cycles minimum (at rated current), 10 operations per minute		
Reference Temperature	40°C		
Operating Temperature	-10 to +60°C (no freezing) Rated current is based on an ambient temperature of 40°C. When the operating temperature exceeds 40°C, derate the rated current by using the factors shown below.		
Storage Temperature	-40 to +60°C (no freezing)		
Operating Humidity	45 to 85% RH (no condensation)		
Storage Humidity	45 to 85% RH (no condensation)		
Terminal Style	Main Circuit Terminal	Spring-up, fingersafe terminal: M4 screw (up to 20A), M5 screw (25A and 30A)	
	Auxiliary/Alarm Contacts, Voltage Coil Terminal	M3.5 screw	
Weight (approx.)	1-pole: 90g, 2-pole: 170g, 3-pole: 260g		

Note 1: 3-pole type is for AC voltage only.

Note 2: For S (instantaneous) tripping curve, humming sound may be caused when used in an AC sinusoidal-wave current circuit around 80% of the rated current, however, the performance of the circuit protector will not be affected.
To avoid unnecessary tripping, do not use in circuits where inrush currents may be present.

Note 3: Relay trip (voltage trip) type is not equipped with an overcurrent trip function.

Do not use the NC1V circuit protectors in environments where they are exposed to extreme temperature, humidity, dust, corrosive gases, vibration, shock, or in a circuit where inrush current may be present, otherwise unnecessary operations and damage may occur.

Operating Temp.	Derating Factor
50°C	0.9
55°C	0.8
60°C	0.7

NC1V Circuit Protectors

Part No. Development

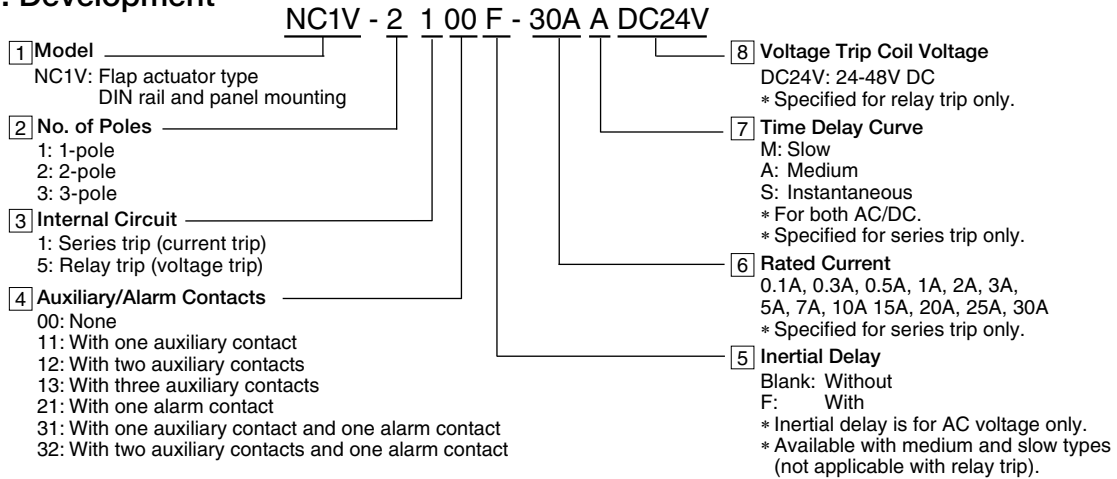

Specify rated current, time delay curve, or voltage trip coil voltage in place of [6][7][8] in the Part No.

Internal Circuit	No. of Poles	Inertial Delay	Auxiliary Contact Alarm Contact	Part No.	Code				
					[6] Rated Current	[7] Time Delay Curve	[8] Voltage Trip Coil Voltage		
Series Trip (Current Trip)	1-pole	-	—	NC1V-1100-[6][7]	0.1A 0.3A 0.5A 1A 2A 3A 5A 7A 10A 15A 20A 25A 30A	M (slow) A (medium) S (instantaneous)	—		
			One Auxiliary Contact	NC1V-1111-[6][7]					
			One Alarm Contact	NC1V-1121-[6][7]					
		With	—	NC1V-1100F-[6][7]					
			One Auxiliary Contact	NC1V-1111F-[6][7]					
			One Alarm Contact	NC1V-1121F-[6][7]					
	2-pole	-	-	—				NC1V-2100-[6][7]	
				One Auxiliary Contact				NC1V-2111-[6][7]	
				Two Auxiliary Contacts				NC1V-2112-[6][7]	
				One Alarm Contact				NC1V-2121-[6][7]	
				One Auxiliary Contact and One Alarm Contact				NC1V-2131-[6][7]	
				With				—	NC1V-2100F-[6][7]
		One Auxiliary Contact	NC1V-2111F-[6][7]						
		Two Auxiliary Contacts	NC1V-2112F-[6][7]						
		One Alarm Contact	NC1V-2121F-[6][7]						
		One Auxiliary Contact and One Alarm Contact	NC1V-2131F-[6][7]						
		3-pole	-					-	—
				One Auxiliary Contact					NC1V-3111-[6][7]
	Two Auxiliary Contacts			NC1V-3112-[6][7]					
	Three Auxiliary Contacts			NC1V-3113-[6][7]					
	One Alarm Contact			NC1V-3121-[6][7]					
	One Auxiliary Contact and One Alarm Contact			NC1V-3131-[6][7]					
	With		—	NC1V-3100F-[6][7]					
			One Auxiliary Contact	NC1V-3111F-[6][7]					
Two Auxiliary Contacts			NC1V-3112F-[6][7]						
Three Auxiliary Contacts			NC1V-3113F-[6][7]						
One Alarm Contact			NC1V-3121F-[6][7]						
One Auxiliary Contact and One Alarm Contact			NC1V-3131F-[6][7]						
Two Auxiliary Contacts and One Alarm Contact	—	NC1V-3132F-[6][7]							
	One Auxiliary Contact	NC1V-3111F-[6][7]							
	Two Auxiliary Contacts	NC1V-3112F-[6][7]							
	Three Auxiliary Contacts	NC1V-3113F-[6][7]							
	One Alarm Contact	NC1V-3121F-[6][7]							
	One Auxiliary Contact and One Alarm Contact	NC1V-3131F-[6][7]							
Relay Trip (Voltage Trip)	1-pole	—	—	NC1V-1500-[8]	—	—	24V DC		
	2-pole	—	—	NC1V-2500-[8]	—	—			
	3-pole	—	—	NC1V-3500-[8]	—	—			

Note: Inertial delay is for AC circuit. Also, time delay curve of S (instantaneous) is not available with inertial delay.

Internal Circuit

1-pole

NC1V-1100 (Without auxiliary/alarm contacts)	NC1V-1111 (With auxiliary contact)	NC1V-1121 (With alarm contact)	NC1V-1500 (Relay Trip)

2-pole

NC1V-2100 (Without auxiliary/alarm contacts)	NC1V-2111 (With auxiliary contact)	NC1V-2121 (With alarm contact)	NC1V-2500 (Relay Trip)

Note: Those with two auxiliary contacts and with one auxiliary contact and one alarm contact have been applied for UL and CCC.

3-pole

NC1V-3100 (Without auxiliary/alarm contacts)	NC1V-3111 (With auxiliary contact)	NC1V-3121 (With alarm contact)	NC1V-3500 (Relay Trip)

Note: Those with two or three auxiliary contacts, with one auxiliary contact and one alarm contact, and with two auxiliary contacts and one alarm contacts have been applied for UL and CCC.

Overcurrent-Time Delay Characteristics (sec at 40°C) [vertical mounting]

Item	Time Delay Curve	Percent of Rated Current								
		100%	125%	150%	175%	200%	400%	600%	800%	1000%
AC (50/60 Hz)/DC	S (instantaneous)	NO TRIP	—	*0.005 to 0.1	0.003 to 0.06	0.0027 to 0.05	0.002 to 0.03	0.002 to 0.028	0.002 to 0.025	0.002 to 0.022
	A (medium)	NO TRIP	*25 to 240	16 to 140	—	6 to 32	0.4 to 4	0.0055 to 1.5	0.004 to 0.8	0.004 to 0.65
	M (slow)	NO TRIP	*60 to 600	30 to 200	—	9 to 60	0.4 to 10	0.006 to 4.5	0.004 to 1.8	0.004 to 0.8
AC (50/60 Hz)	With Inertial Delay A (medium)	NO TRIP	25 to 240	—	—	6 to 32	0.8 to 6	0.09 to 3.5	0.02 to 1.8	0.01 to 1.0
	With Inertial Delay M (slow)	NO TRIP	60 to 600	—	—	10 to 60	0.8 to 10	0.06 to 4.5	0.02 to 3	0.01 to 1.75

*: MAY TRIP on DC

NC1V Circuit Protectors

Time Delay Curves at 40°C

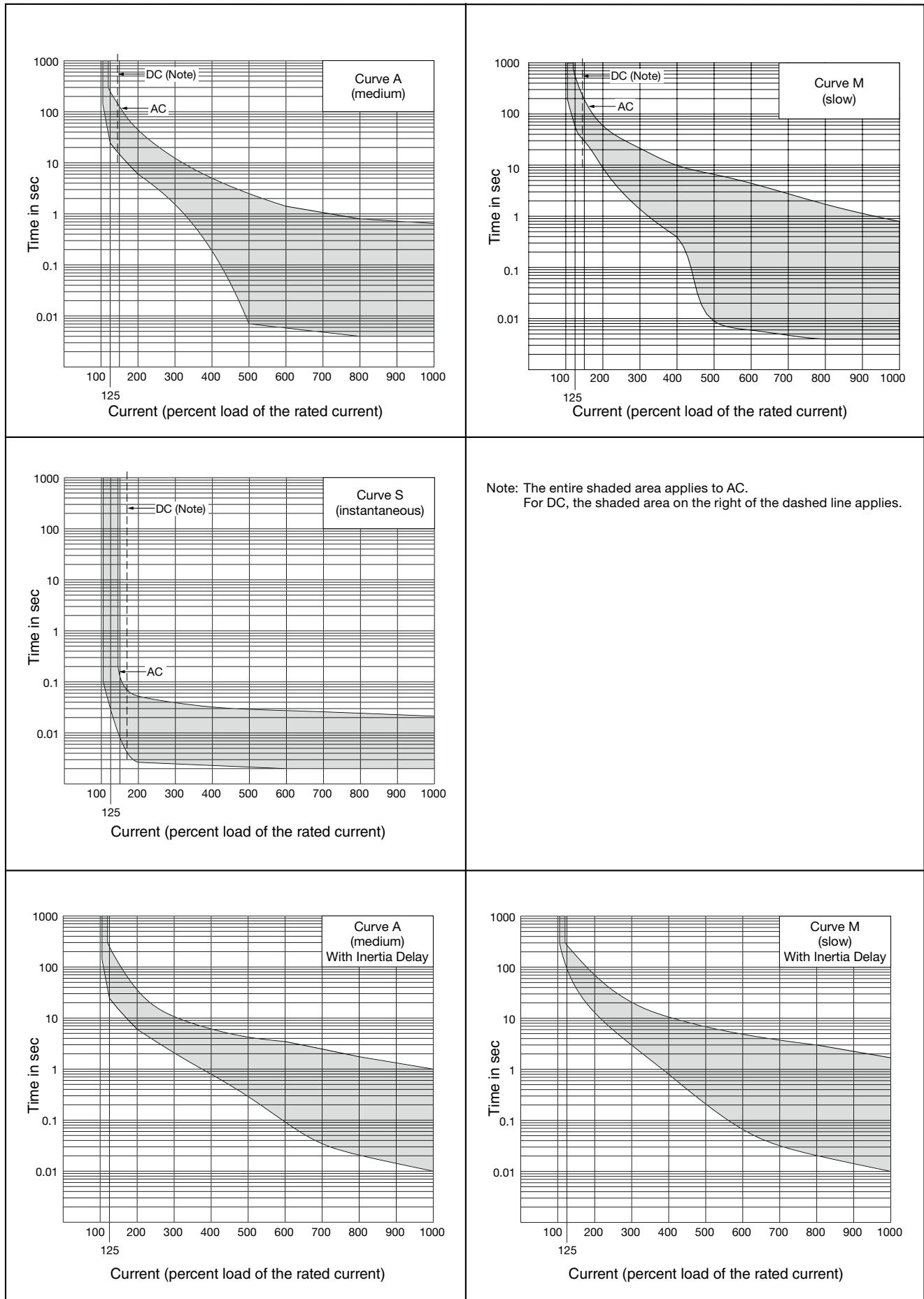

Time Delay Curve and Ambient Temperature

NC1V circuit protectors employ an electromagnetic tripping system, where the rated current (trip current) is not affected by ambient temperatures. But the time delay may vary with the oil viscosity in the oil dash pot. Lower oil viscosity at higher temperatures results in a shorter delay, whereas at lower temperatures the delay will be longer.

Temperature Correction Curve

The time delay curves on the preceding page are measured at 40°C. With reference to the following curves, time delays can be corrected according to ambient temperature.

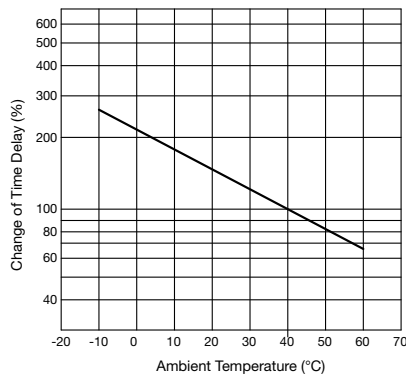

The time delay is based on an ambient temperature of 40°C. Time delays at other temperatures are corrected according to the temperature correction curve. The time delay of the instantaneous time delay curve (S) is not affected by the ambient temperature.

When operating temperature exceeds 40°C, derate the rated current by multiplying the derating factor shown on the right.

Operating Temp.	Derating Factor
50°C	0.9
55°C	0.8
60°C	0.7

Inertial Delay

Inertial delay is designed not to trip on a non-repeating single pulse of 20 times the rated current (peak value) for a duration of 8 ms. In addition, circuit protectors equipped with inertial delay do not respond to high inrush currents caused by transformer or lamp loads, but perform the specified interruption on the subsequent overcurrents. Inertial delay is available on AC circuits, and is not available with the series trip curve S (instantaneous).

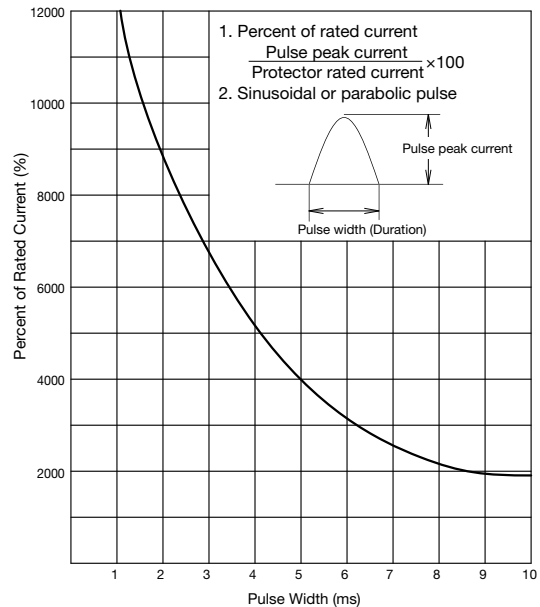

Impedance and Coil Resistance

Series Trip (Current Trip) (initial value) at 25°C

Rated Current	For AC 50/60 Hz Impedance (Ω)		For DC Resistance (Ω)	
	Curve S	Curves A, M	Curve S	Curves A, M
0.1A	66.0	116.0	43.0	106.0
0.3A	6.6	11.0	4.1	10.0
0.5A	1.92	3.65	0.86	3.40
1A	0.50	0.93	0.25	0.90
2A	0.16	0.27	0.11	0.25
3A	0.07	0.12	0.050	0.11
5A	0.025	0.050	0.015	0.045
7A	0.014	0.027	0.011	0.025
10A	0.007	0.021	0.005	0.020
15A	0.006	0.010	0.005	0.009
20A	0.005	0.006	0.004	0.005
25A	0.004	0.005	0.004	0.005
30A	0.003	0.004	0.003	0.004

Tolerance: ±25% (up to 20A),
±50% (25A and 30A)

Relay Trip (Voltage Trip)

at 25°C

Tripping Voltage	For DC Resistance (Ω)
24-48V	100.0

Tolerance: ±25%

Voltage Drop Due to Coil Resistance or Impedance

The internal resistance or impedance of a circuit protector tends to be larger for a smaller rated current. Therefore, when circuit protectors of a small rated current are used, voltage drop should be taken into consideration. Internal resistance also varies with time delay curves, which should also be considered during installation.

Main Contact - Auxiliary/Alarm Contact

[Auxiliary Contact]

Main Contact	NO contact	NC Contact
ON	closed	open
Tripped	open	closed
OFF	open	closed

[Alarm Contact]

Main Contact	NO contact	NC Contact
ON	open	closed
Tripped	closed	open
OFF	open	closed

NC1V Circuit Protectors

Dimensions

1-pole

All dimensions in mm.

<p>NC1V-1100</p>	<p>M4 Terminal Screw (up to 20A) M5 Terminal Screw (25A, 30A)</p> <p>2-ϕ4.5 Holes (for screw mounting)</p> <p>DIN Rail (BAA, BAP, BADA)</p>	
<p>NC1V-1111 (Auxiliary Contact) NC1V-1121 (Alarm Contact)</p>	<p>M4 Terminal Screw (up to 20A) M5 Terminal Screw (25A, 30A)</p> <p>M3.5 Terminal Screw</p> <p>2-ϕ4.5 Holes (for screw mounting)</p> <p>DIN Rail (BAA, BAP, BADA)</p>	<p>Mounting Hole Layout (M4 Mounting Screws)</p>
<p>NC1V-1500 (Relay Trip)</p>	<p>M5 Terminal Screw (30A)</p> <p>Coil Terminal</p> <p>M3.5 Terminal Screw</p> <p>2-ϕ4.5 Holes (for screw mounting)</p> <p>DIN Rail (BAA, BAP, BADA)</p>	

2-pole

<p>NC1V-2100</p>	<p>M4 Terminal Screw (up to 20A) M5 Terminal Screw (25A, 30A)</p> <p>2-ϕ4.5 Holes (for screw mounting)</p> <p>DIN Rail (BAA, BAP, BADA)</p>	<p>Mounting Hole Layout (M4 Mounting Screws)</p>
------------------	---	--

NC1V Circuit Protectors

2-pole

<p>NC1V-2111 (one auxiliary contact) NC1V-2112 (two auxiliary contacts) NC1V-2121 (one alarm contact) NC1V-2131 (one auxiliary contact and one alarm contact)</p>	<p>M4 Terminal Screw (up to 20A) M5 Terminal Screw (25A, 30A)</p> <p>NC NO</p> <p>M3.5 Terminal Screw</p> <p>2-ϕ4.5 Holes (for screw mounting)</p> <p>29.5</p> <p>71.4</p> <p>56.0</p> <p>35.0</p> <p>6.6</p> <p>66.0</p> <p>48.3</p> <p>30.6</p> <p>72.5</p> <p>48.4</p> <p>39.4</p> <p>78.8</p> <p>5.0</p> <p>15.3</p> <p>33.0</p> <p>DIN Rail (BAA, BAP, BADA)</p> <p>The dimensions are for NC1V-2111 and NC1V-2121.</p>	<p>Mounting Hole Layout (M4 Mounting Screws)</p> <p>29.5</p> <p>71.4</p> <p>2-M4</p>
<p>NC1V-2500 (Relay Trip)</p>	<p>M5 Terminal Screws (30A)</p> <p>Coil Terminal</p> <p>M3.5 Terminal Screw</p> <p>2-ϕ4.5 Holes (for screw mounting)</p> <p>29.5</p> <p>71.4</p> <p>56.0</p> <p>35.0</p> <p>6.6</p> <p>66.0</p> <p>48.3</p> <p>30.6</p> <p>72.5</p> <p>48.4</p> <p>39.4</p> <p>78.8</p> <p>5.0</p> <p>15.3</p> <p>33.0</p> <p>DIN Rail (BAA, BAP, BADA)</p>	<p>Mounting Hole Layout (M4 Mounting Screws)</p> <p>29.5</p> <p>71.4</p> <p>2-M4</p>

3-pole

<p>NC1V-3100</p>	<p>M4 Terminal Screw (up to 20A) M5 Terminal Screw (25A, 30A)</p> <p>2-ϕ4.5 Holes (for screw mounting)</p> <p>47.0</p> <p>71.4</p> <p>56.0</p> <p>52.5</p> <p>6.6</p> <p>66.0</p> <p>48.3</p> <p>30.6</p> <p>72.5</p> <p>44.0</p> <p>39.4</p> <p>78.8</p> <p>5.0</p> <p>15.3</p> <p>33.0</p> <p>DIN Rail (BAA, BAP, BADA)</p>	<p>Mounting Hole Layout (M4 Mounting Screws)</p> <p>47.0</p> <p>71.4</p> <p>2-M4</p>
<p>NC1V-3111 (one auxiliary contact) NC1V-3112 (two auxiliary contacts) NC1V-3113 (three auxiliary contacts) NC1V-3121 (one alarm Contact) NC1V-3131 (one auxiliary contact and one alarm contact) NC1V-3132 (two auxiliary contacts and one alarm contact)</p>	<p>M4 Terminal Screw (up to 20A) M5 Terminal Screw (25A, 30A)</p> <p>NC NO</p> <p>M3.5 Terminal Screw</p> <p>2-ϕ4.5 Holes (for screw mounting)</p> <p>47.0</p> <p>71.4</p> <p>56.0</p> <p>52.5</p> <p>6.6</p> <p>66.0</p> <p>48.3</p> <p>30.6</p> <p>72.5</p> <p>48.4</p> <p>39.4</p> <p>78.8</p> <p>5.0</p> <p>15.3</p> <p>33.0</p> <p>DIN Rail (BAA, BAP, BADA)</p> <p>The dimensions are for NC1V-3111 and NC1V-3121.</p>	<p>Mounting Hole Layout (M4 Mounting Screws)</p> <p>47.0</p> <p>71.4</p> <p>2-M4</p>

NC1V Circuit Protectors (Accessories)

3-pole

All dimensions in mm.

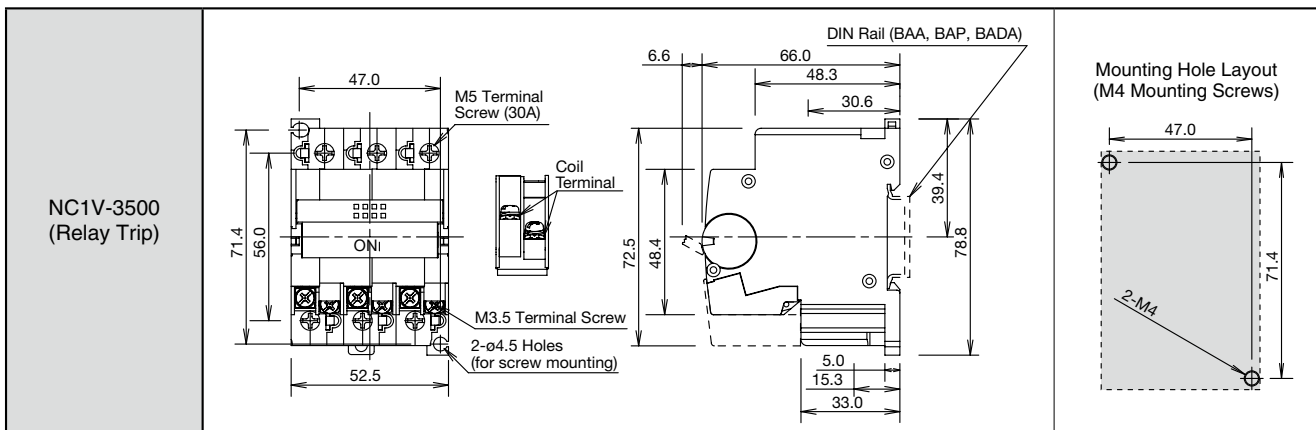

Accessories

All dimensions in mm.

Shape	Material	Part No.	Ordering No.	Package Quantity	Remarks
Panel Mounting Bracket (Note) 	1-pole 2-pole 3-pole Bracket: Steel Wiring clip: brass (terminal), steel (screw, washer)	NC9Z-MA11 NC9Z-MA21 NC9Z-MA31	NC9Z-MA11 NC9Z-MA21 NC9Z-MA31	1	<ul style="list-style-type: none"> Used for mounting NC1V circuit protectors in a panel cut-out. Supplied with two wiring clips for each pole, used for wiring from the rear. For 1-pole: 2 wiring clips For 2-pole: 4 wiring clips For 3-pole: 6 wiring clips
Marking Plate 	PBT	NC9Z-PW1	NC9Z-PW1PN10	10	<ul style="list-style-type: none"> Available for 2-pole circuit only. For use on 1-pole circuit protectors, break the marking plate into two halves. Label is supplied by the user.
Padlock Attachment 	Polyamide body with stainless steel pin	NC9Z-LK1	NC9Z-LK1	1	<ul style="list-style-type: none"> Locks the retractable actuator in the off position to prevent NC1V from being switched on inadvertently. Can be used on 1-, 2-, and 3-pole.
DIN Rail (35mm-wide) 	Length: 1000mm Aluminum Steel Aluminum	BAA1000 BAP1000 BADA1000	BAA1000PN10 BAP1000PN10 BADA1000PN10	10	Weight: approx. 200g Weight: approx. 320g Weight: approx. 280g
End Clip 	Steel (trivalent chromate)	BNL6	BNL6PN10	10	<ul style="list-style-type: none"> Applicable rail: BAA, BAP, BADA Weight: approx. 15g

Note: Cannot be used with NC1V with auxiliary or alarm contact.

NC1V Circuit Protectors (Accessories)

Dimensions

NC9Z-MA Panel Mounting Bracket

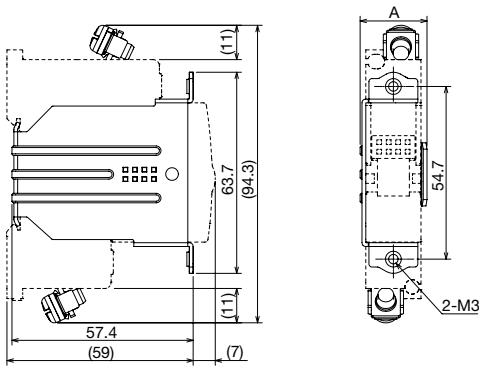

Dimensions A and B

Dimension	A	B
1-pole	21.2	17.8
2-pole	38.7	35.3
3-pole	56.2	52.8

Mounting Hole Layout

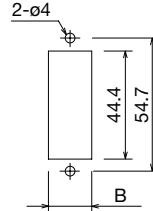

NC9Z-TA1 Wiring Clip

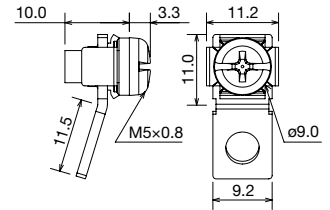

Insulation Sleeve

When using wiring clips on 2- or 3-pole circuit protectors, install UL/CSA-rated insulation sleeves on the crimping terminals to ensure the air gap required by UL1077.

Applicable Insulation Sleeves (Example)

- Nissei Eco (V-38)
- Tokyo Dip (TP-038)
- Nichifu (TIC38)

Applicable Crimping Terminal

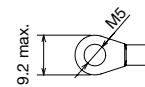

Tightening torque: 1.8 to 2.2 N-m

Materials

- Panel Mounting Bracket: Steel
- Wiring Clip: Brass (terminal strip)
Steel (screw, washer)

Panel Mounting Screw Length (Dimension C in mm)

Applicable Panel Thickness: 0.8 to 3.2 mm

The outside diameter of the M3 screw (including washer) must be 7 mm maximum.

Panel thickness (mm)	0.8	1.0	1.2	1.4	1.6	1.8	2.0	2.3	2.6	3.2
Without washer	5	5	6	6	6	6	6	8	8	8
With plain washer (0.5 thick)	6	6	6	6	6	6	8	8	8	8
With spring washer (0.7 thick)	6	6	6	6	6	8	8	8	8	8
With plain washer (0.5 thick) and spring washer (0.7 thick)	6	6	6	8	8	8	8	8	8	8
Countersunk head screw	—	—	—	—	—	—	6	6	8	8

Tightening torque: 0.5 to 0.8 N-m

The screw length behind the panel must be 9 mm maximum.

NC9Z-PW1 Marking Plate

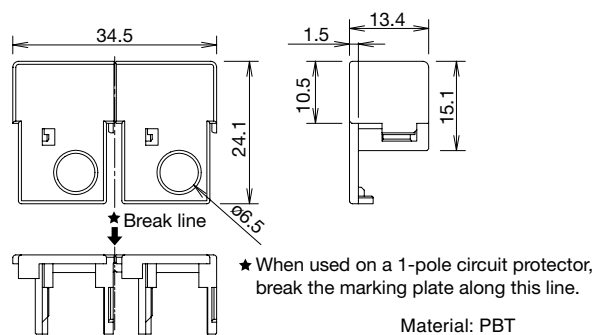

Marking Plate Installed on the Circuit Protector

When installed on a 2-pole circuit protector

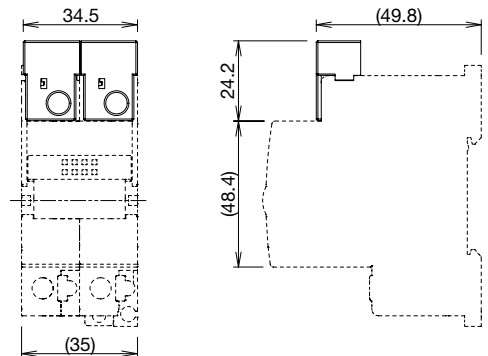

NC98-LK1 Padlock Attachment

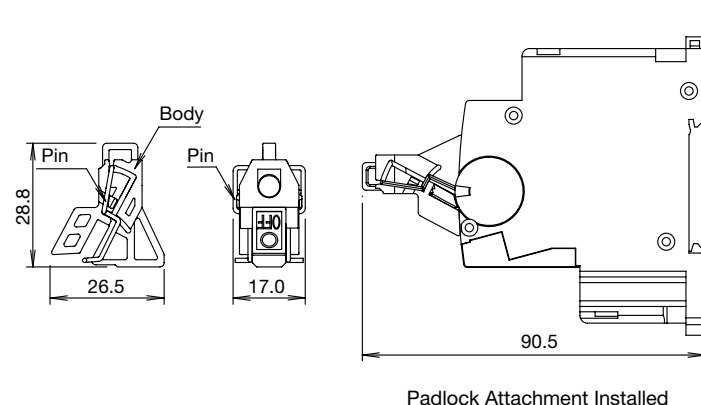

Rail

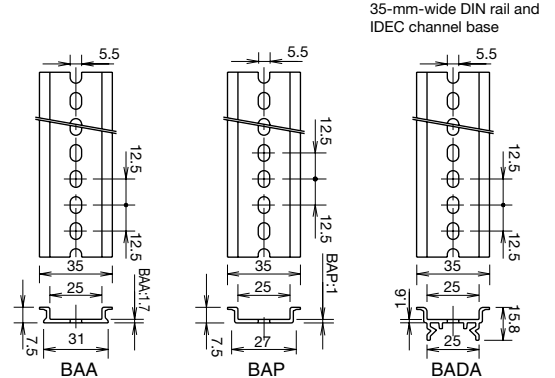

35-mm-wide DIN rail and IDEC channel base

NC1V Circuit Protectors Instructions

Replacement Parts

All dimensions in mm.

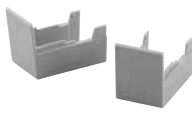
Shape	Material	Part No.	Ordering No.	Package Quantity	Remarks
	PA66	NC1V-AUX-CV	NC1V-AUX-CV	1	
Wiring Clip	Terminal: Brass Screw/washer: Steel	NC9Z-TA1	NC9Z-TA1PN10	10	

Instructions

Installation Angle

Tripping method is hydraulic magnetic. Minimum operating current varies with installation angle. Operating currents are influenced by the weight of movable iron core. With reference to the following figures, correct the rated current.

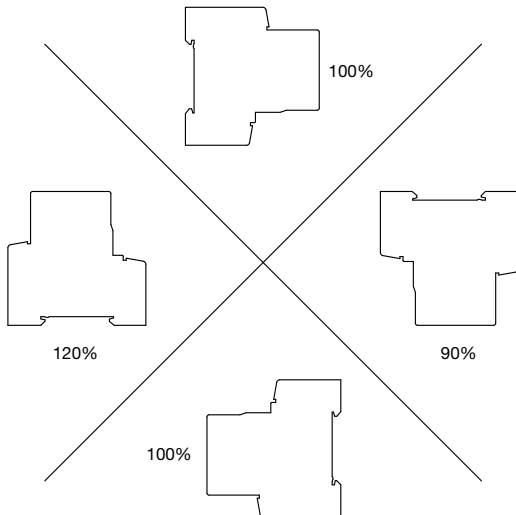

Minimum operating current is calculated from the following formula:

$$(\text{Minimum operating current}) = (\text{Rated current}) \times (\text{Correction factor by installation angle}) \times (\text{Reference minimum tripping current rate})$$

DIN Rails

[Installation on DIN Rail]

1. Fasten the DIN rail securely.
2. With the latch facing downward, install the NC1V circuit protector on the DIN rail as shown below.

[Removal from DIN Rail]

Using a flat screwdriver, pull the latch on the circuit protector to remove from the DIN rail.

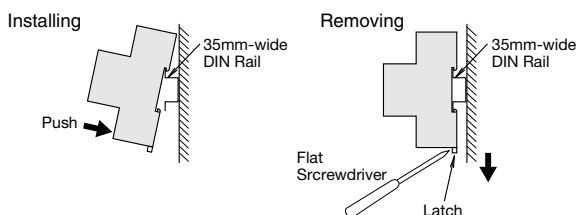

Applicable Wire and Crimp Terminal

Terminal	Terminal Screw	Connectable Wire Size (mm ²)	Applicable Crimping Terminal	Tightening Torque (N·m)
Main Circuit Terminals	Spring-up, fingersafe, slotted Phillips screw with square washer (up to 20A)	0.25 to 1.65	R1.25-4	1 to 1.4
		1.04 to 2.63	R2-4	
		2.63 to 6.64	R5.5-4	
	Spring-up fingersafe terminal (25A and 30A)	0.25 to 1.65	R1.25-5	1.8 to 2.2
1.04 to 2.63		R2-5		
Auxiliary Contact Alarm Contact Voltage Coil Terminals	Slotted Phillips screw with square washer	0.25 to 1.65	R1.25-3.5	0.7 to 0.9
		1.04 to 2.63	R2-3.5	

- For wiring the main circuit terminal, use the applicable crimp terminals and tighten to the recommended tightening torque.
- When using the NC1V circuit protector as CSA-certified product, use with CSA-certified crimp terminal.
- When using the NC1V circuit protector as UL-listed product, use with UL-listed crimp terminal.

Panel Mounting Screw (not supplied)

Screw Size	Tightening Torque	Shape
M4	0.8 to 1.0 N·m	Spring Washer Plain Washer

Product Markings (Example: NC1V-1111-30AA)

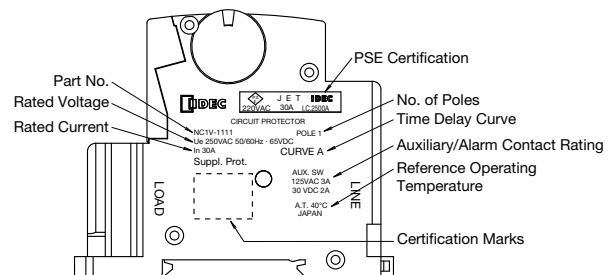

Installation of Auxiliary/Alarm Terminal Cover

After wiring the terminals, install the terminal cover by aligning the terminal cover with the circuit protector as shown below.

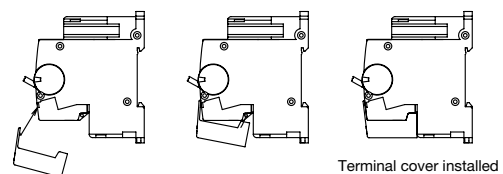

NC1V Circuit Protectors Instructions

Instructions

Installing Auxiliary/Alarm Terminal Cover

Connect the terminal before installing the terminal cover.

Installing

Attach the latch on TOP side and install the terminal cover as shown below.

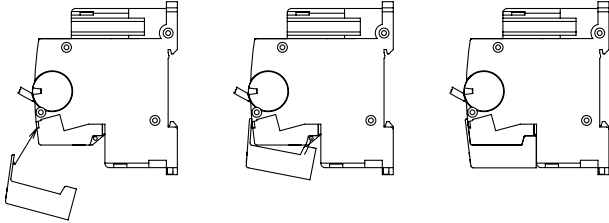

Installing NC9Z-MA Panel Mounting Brackets

1. Insert the wiring clip into the terminal of the circuit protector, and tighten.
 - Tightening torque to the main circuit terminal
20A max. (M4): 1 to 1.4 N·m
25A, 30A (M5): 1.8 to 2.2 N·m
2. Insert the panel mounting bracket to the circuit protector.
3. Install the rear of the panel mounting bracket into the DIN rail recess on the circuit protector and push in the clamp.

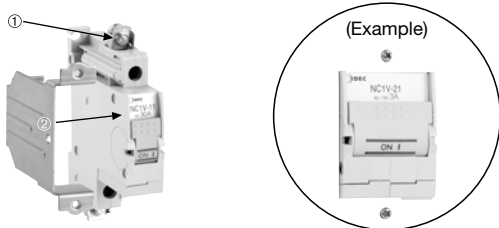

Note: NC1V circuit protectors with auxiliary/alarm contacts cannot be used with mounting brackets.

Installing the NC98-PW1 Marking Plate

Available for 2-pole circuit protectors only.

For use on 1-pole circuit protectors, break the marking plate into two halves.

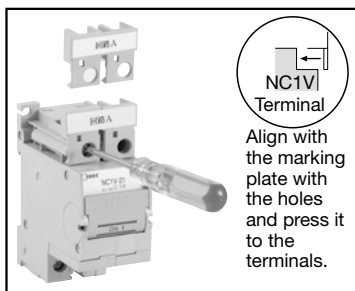

Marking Range

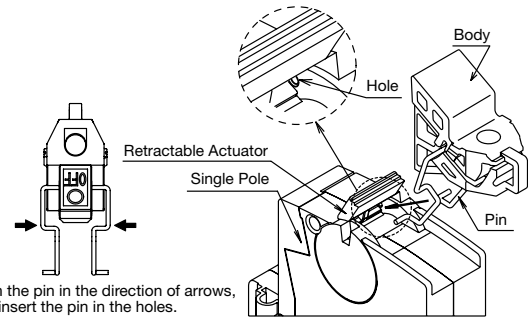
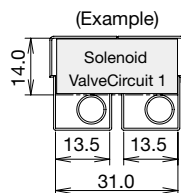

Push the pin in the direction of arrows, and insert the pin in the holes.

② Turn the body.

③ Install the body on the retractable actuator as shown below.

④ Slide the pin to the lock position.

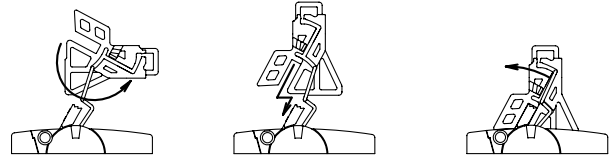

Padlock

- The padlock is not supplied with the padlock attachment and must be supplied by the user.
- The total weight of the padlock can be a maximum of 45g. Make sure the padlock weight does not exceed 45g, otherwise the NC1V circuit protector may be damaged.
- Applicable Padlock Size

(A)	(B)	C	D	E	(F)	G
19 to 25	35 to 42	9 to 11.5	4 to 4.5	11 to 15	8 to 10	7.5 to 9.0

Note: (A) (B) (F) are for reference only.

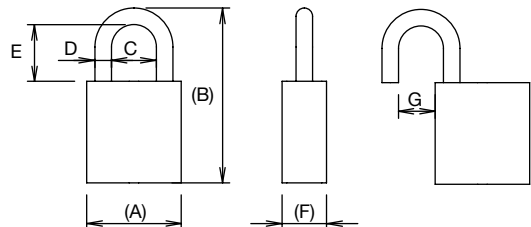

Recommended Padlock

Manufacturer	Part No.
Alpha	1000-25
Master Lock	4120

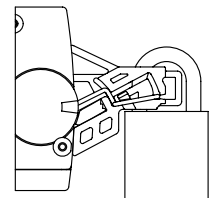

Installing the NC98-LK1 Padlock Attachment

- ① Pull down the retractable actuator, and install the padlock attachment on the circuit protector.

1-pole: Insert the pin into the holes under the retractable actuator.

2- or 3-pole: Insert the pin into the holes in the center of the circuit protector.

Safety Precautions

- When using the padlock, do not use the NC1V circuit protector where it is subject to vibration or shock, otherwise failure or damage may result.
- Do not apply a force of more than 50N on the retractable actuator, otherwise the actuator will be damaged.
- When using three or more 1-pole NC1V circuit protectors adjacently, facilitate installing the padlock attachment by providing a clearance of 6mm minimum between the protectors, or by using the tweezers or flat screwdriver.

NH1 Series Circuit Protectors

Wide Range of Applications from Office Automation and Consumer Use to Factory Automation.

- Compact, lightweight, and high-performance circuit protectors.
- Rocker type snaps into a panel.
- Rated voltage: 250V AC and 65V DC
- 35mm-wide DIN rail mounting (NH1V)
- Available with dual-coil
- Available with auxiliary contact or alarm contacts.
- Available with inertia delay
- Hydraulic-magnetic tripping system
- Safe trip-free mechanism
- Available in tab terminal and screw-terminal.

This product is recognized by Underwriters Laboratories under UL1077 as a "Supplementary Protector."

Applicable Standards	Mark	Certification Organization / File No.
UL1077 CSA C22.2 No. 235 (Note 1)		UL/c-UL recognized File No. E68029
EN60934 (VDE0642) (Note 2)		No. 107852
EN60932 (Note 2)		EU Low Voltage Directive
GB17701		CCC No. 2005010307152360
Electrical Appliance and Material Safety Law Technical Standard		JET

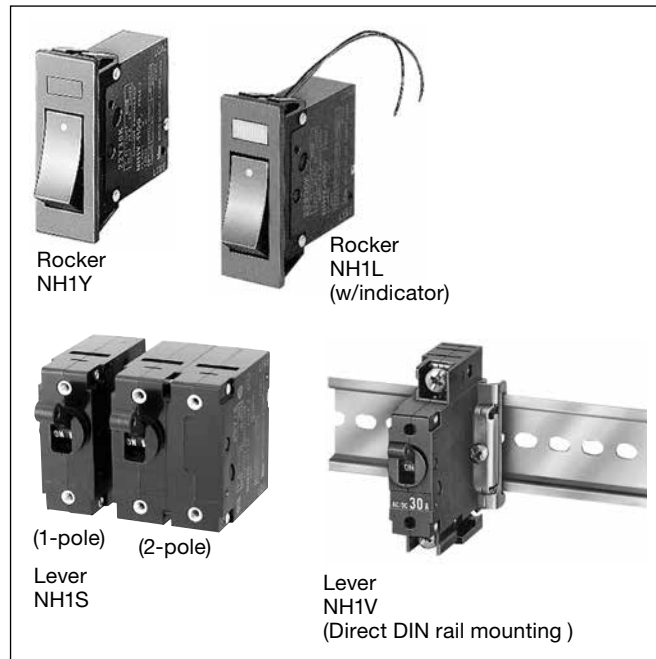

For details, see the list of standard certified products in the back of this catalog.

Note 1: Series trip, relay trip, dual coil (for AC)

Note 2: Series trip

Specifications

Model	NH1S	NH1Y	NH1L	NH1V	Dual-coil
					NH1S
Operator Style	Lever	Rocker	Rocker (w/indicator)	Lever	Lever
Protection Method	Hydraulic-magnetic tripping system				Hydraulic-magnetic tripping system
Internal Circuit	Series trip (Current trip) Relay trip (Voltage trip)	Series trip with auxiliary contacts	Series trip with alarm contacts	Series trip with alarm contacts (NH1S and NH1V only)	Series trip (Current trip) + Relay trip (Voltage trip)
No. of Poles	1, 2, 3 poles	1, 2 poles	1, 2 poles	1, 2, 3 poles	1, 2 poles
Rated Voltage	250V AC 50/60Hz, 65V DC				250V AC 50/60Hz, 65V DC
Minimum Applicable Load	24V AC/DC, 100mA (reference value)				
Rated Current	Current trip: 0.5A, 0.75A, 1A, 2A, 3A, 5A, 7.5A, 10A, 15A, 20A, 25A, 30A				Current trip: 2A, 3A, 5A, 7.5A, 10A, 15A
Trip Voltage	100V AC 50/60Hz, 24V DC (operating at 90% of the rated voltage or higher, at 25°C) Voltage application duration: 1 sec maximum Trip time: 0.05 sec maximum (at the rated voltage)				Trip coil voltage: 24V DC, 100V AC (operating at 90% of the rated voltage or higher, at 25°C) Voltage application duration: 1 sec - max. Trip time: 0.05 sec max. (at the rated voltage)
Rated Interrupting Current	250V AC 50/60Hz 1000A, 65V DC 1000A (UL/C-UL ratings) 220V AC 50/60Hz 1000A (☞)				
Auxiliary Contact Alarm Contact	SPDT microswitch 250V AC, 3A (resistive load)				-
Reference Temperature	+25°C				
Operating Temperature	-40 to +85°C (no freezing)				
Storage Temperature	-40 to +85°C (no freezing)				
Operating Humidity	45 to 85% RH (no condensation)				
Storage Humidity	45 to 85% RH (no condensation)				
Insulation Resistance	100 MΩ minimum (500V DC megger)				
Dielectric Strength	Between operator and live part, between terminals when main contacts are open, between live parts of different poles, and between main terminal and auxiliary contact terminal: 3750V AC, 1 min (NH1V: 1500V AC, 1 min) Between terminals when auxiliary contacts are open: 600V AC, 1 min				Between operator and live part, between terminals when main contacts are open, between live parts of different poles, between voltage trip terminal and main terminal: 1500V AC, 1 min.
Vibration Resistance	Damage limits: 10 to 55 Hz, 100 m/s ² (1, 2, 3 pole) Operating extremes: 10 to 55 Hz, 98 m/s ² (1, 2, 3 pole) (with the rated current applied)				
Shock Resistance	Damage limits: 1000 m/s ² , Operating extremes: 500 m/s ² with the rated current applied. (Auxiliary/alarm contact: 300 m/s ²)				
Life	10,000 cycles min. (Electrically 6,000 cycles: 6 operations per minute at the rated current, mechanically 4,000 cycles: 6 operations per minute)				
Terminal Style	Main terminal: Tab terminal #250, M4 screw terminal Auxiliary terminal: Tab terminal #110			Main terminal: M4 screw terminal (20A max.) M5 screw terminal (25, 30A) Auxiliary terminal: M3.5 screw terminal	Main terminal: Tab terminal #250 Auxiliary terminal: Tab terminal #187
Mounting Style	Screw mounting	Snap mounting		Screw mounting, DIN rail mounting	Screw mounting
Weight (Approx.)	1-pole: 45g 2-pole: 90g 3-pole: 135g	1-pole: 50g 2-pole: 100g		1-pole: 65g 2-pole: 130g 3-pole: 195g	1-pole: 45g 2-pole: 90g

- Do not use the NH1 series circuit protectors in environments where they are exposed to extreme temperature, humidity, dust, corrosive gases, vibration, shock, or in a circuit where inrush current may be present, otherwise unnecessary operations and damage may occur.

Rocker Color, Rocker Indication (NH1Y/NH1L)

Rocker Color (Code)	Rocker Indication (Code)
Black (blank) Red (R), Green (G), White (W)	(blank)
	(A)
	(C)
	(D)

Note: Rocker indication is white (black when rocker color is white).

Operating Voltage of Indicator (NH1L)

Indicator	Rated Voltage	Code	
Neon (Red)	125V AC, 50/60Hz (operating voltage: 100 to 125V AC)	1	
LED (Red) [Note]	For AC/DC (operating voltage: within +10% of the rated voltage)	6V	3
		12V	4
		24V	5
		48V	6

Note: Both indicators contain a current limiting resistor.

Operation of Auxiliary Contacts

Since auxiliary contact operations are interlocked with ON/OFF positions of main terminal, operating status of the circuit protector can be monitored using a lamp. Auxiliary contacts also serve as a control of auxiliary circuits.

Operator Position	NO Contact	NC Contact
ON	Closed	Open
Tripped	Open	Closed
OFF	Open	Closed

Operation of Alarm Contacts

Alarm contacts are not interlocked with main contacts and operate only when an overcurrent occurs.

Operator Position	NO Contact	NC Contact
ON	Open	Closed
Tripped	Closed	Open
OFF	Open	Closed

Part No. Example

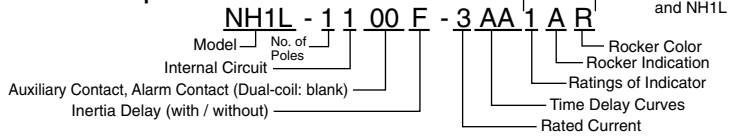

Part No. Development

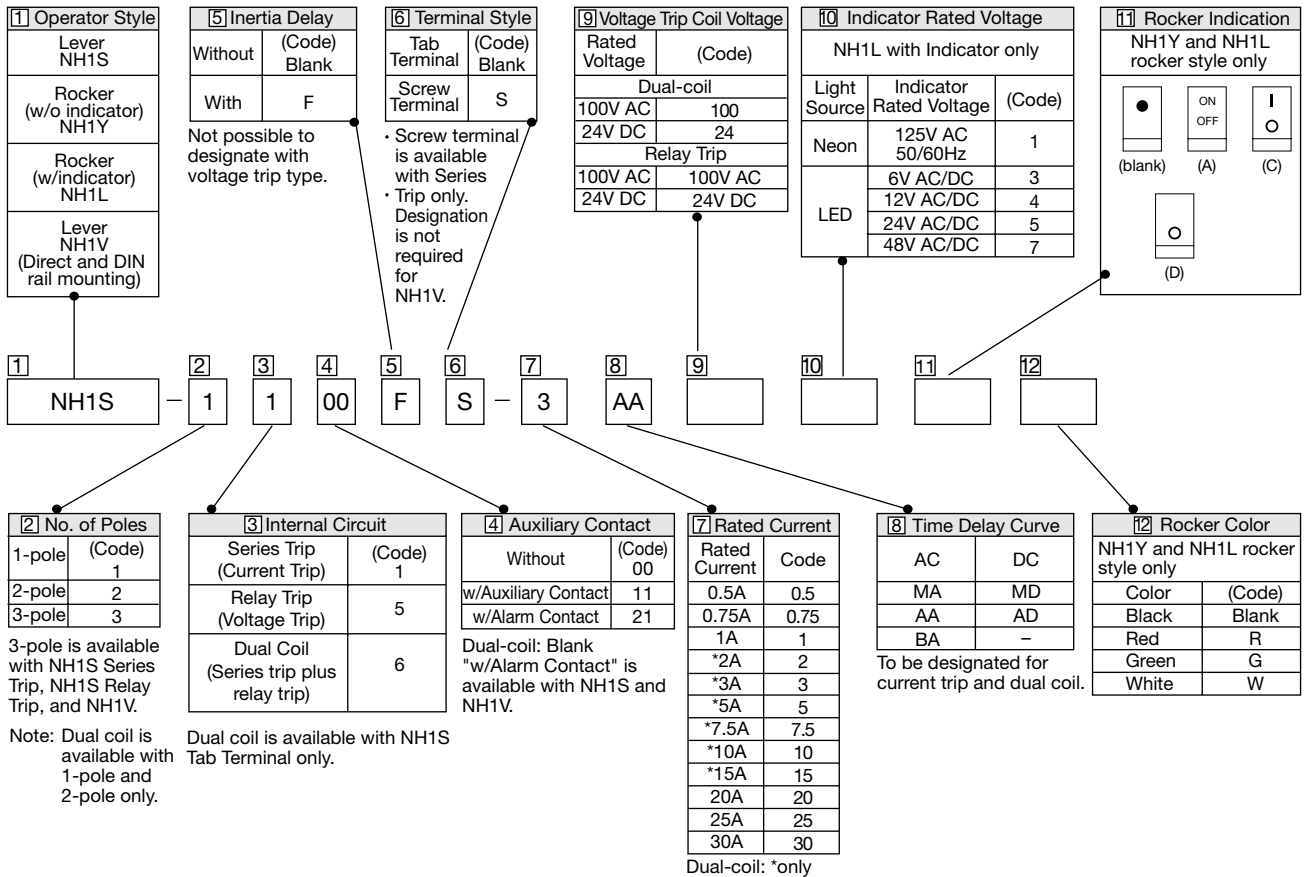

NH1 Series Circuit Protectors

NH1S (Lever)

Specify a rated current, time delay curve, and rated voltage in place of [7] [8] [9].

Package Quantity: 1

Internal Circuit	No. of Poles	Terminal Style	Inertia Delay	Auxiliary Contact Alarm Contact	Part No.	Designation Code		
						[7] Rated Current	[8] Time Delay Curve	[9] Rated Voltage
Series Trip Current Trip	1	Tab Terminal	Without	Without	NH1S-1100- [7] [8]			
				w/Auxiliary Contact	NH1S-1111- [7] [8]			
				w/Alarm Contact	NH1S-1121- [7] [8]			
		With	Without	NH1S-1100F- [7] [8]				
			w/Auxiliary Contact	NH1S-1111F- [7] [8]				
			w/Alarm Contact	NH1S-1121F- [7] [8]				
	Screw Terminal	Without	Without	NH1S-1100S- [7] [8]				
			w/Auxiliary Contact	NH1S-1111S- [7] [8]				
			w/Alarm Contact	NH1S-1121S- [7] [8]				
		With	Without	NH1S-1100FS- [7] [8]				
			w/Auxiliary Contact	NH1S-1111FS- [7] [8]				
			w/Alarm Contact	NH1S-1121FS- [7] [8]				
Series Trip Current Trip	2	Tab Terminal	Without	Without	NH1S-2100- [7] [8]	0.5A 0.75A 1A 2A 3A 5A 7.5A 10A 15A 20A 25A 30A	AA BA MA AD MD	-
				w/Auxiliary Contact	NH1S-2111- [7] [8]			
				w/Alarm Contact	NH1S-2121- [7] [8]			
		With	Without	NH1S-2100F- [7] [8]				
			w/Auxiliary Contact	NH1S-2111F- [7] [8]				
			w/Alarm Contact	NH1S-2121F- [7] [8]				
	Screw Terminal	Without	Without	NH1S-2100S- [7] [8]				
			w/Auxiliary Contact	NH1S-2111S- [7] [8]				
			w/Alarm Contact	NH1S-2121S- [7] [8]				
		With	Without	NH1S-2100FS- [7] [8]				
			w/Auxiliary Contact	NH1S-2111FS- [7] [8]				
			w/Alarm Contact	NH1S-2121FS- [7] [8]				
Series Trip Current Trip	3	Tab Terminal	Without	Without	NH1S-3100- [7] [8]			
				w/Auxiliary Contact	NH1S-3111- [7] [8]			
				w/Alarm Contact	NH1S-3121- [7] [8]			
		With	Without	NH1S-3100F- [7] [8]				
			w/Auxiliary Contact	NH1S-3111F- [7] [8]				
			w/Alarm Contact	NH1S-3121F- [7] [8]				
	Screw Terminal	Without	Without	NH1S-3100S- [7] [8]				
			w/Auxiliary Contact	NH1S-3111S- [7] [8]				
			w/Alarm Contact	NH1S-3121S- [7] [8]				
		With	Without	NH1S-3100FS- [7] [8]				
			w/Auxiliary Contact	NH1S-3111FS- [7] [8]				
			w/Alarm Contact	NH1S-3121FS- [7] [8]				
Relay Trip Voltage Trip	1	Tab Terminal	Without	Without	NH1S-1500- [9]	-	-	100V AC 24V DC
	2			Without	NH1S-2500- [9]			
	3			Without	NH1S-3500- [9]			
Dual-coil	1	Tab Terminal	Without	Without	NH1S-16- [7] [8] [9]	2A 3A 5A 7.5A 10A 15A	AA BA MA AD MD	100V AC 24V DC
			With	NH1S-16F- [7] [8] [9]				
	2	Tab Terminal	Without	Without	NH1S-26- [7] [8] [9]			
			With	NH1S-26F- [7] [8] [9]				

NH1 Series Circuit Protectors

NH1Y (Rocker)

Specify a rated current, time delay curve, rated voltage, rocker indication, and rocker color in place of **7 8 9 11 12**.

Package Quantity: 1

Internal Circuit	No. of Poles	Terminal Style	Inertia Delay	Auxiliary Contact Alarm Contact	Part No.	Designation Code				
						7 Rated Current	8 Time Delay Curve	9 Rated Voltage	11 Rocker Indication	12 Rocker Color
Series Trip Current Trip	1	Tab Terminal	Without	Without	NH1Y-1100- 7 8 11 12	0.5A 0.75A 1A 2A 3A 5A 7.5A 10A 15A 20A 25A 30A	AA BA MA AD MD	-	Blank, A, C, D	Blank, R, G, W
				w/Auxiliary Contact	NH1Y-1111- 7 8 11 12					
				w/Alarm Contact	-					
		With	Without	NH1Y-1100F- 7 8 11 12						
			w/Auxiliary Contact	NH1Y-1111F- 7 8 11 12						
			w/Alarm Contact	-						
	Screw Terminal	Without	Without	NH1Y-1100S- 7 8 11 12						
			w/Auxiliary Contact	NH1Y-1111S- 7 8 11 12						
			w/Alarm Contact	-						
		With	Without	NH1Y-1100FS- 7 8 11 12						
			w/Auxiliary Contact	NH1Y-1111FS- 7 8 11 12						
			w/Alarm Contact	-						
Series Trip Current Trip	2	Tab Terminal	Without	Without	NH1Y-2100- 7 8 11 12	7.5A 10A 15A 20A 25A 30A	AA BA MA AD MD	-	Blank, A, C, D	Blank, R, G, W
				w/Auxiliary Contact	NH1Y-2111- 7 8 11 12					
				w/Alarm Contact	-					
		With	Without	NH1Y-2100F- 7 8 11 12						
			w/Auxiliary Contact	NH1Y-2111F- 7 8 11 12						
			w/Alarm Contact	-						
	Screw Terminal	Without	Without	NH1Y-2100S- 7 8 11 12						
			w/Auxiliary Contact	NH1Y-2111S- 7 8 11 12						
			w/Alarm Contact	-						
		With	Without	NH1Y-2100FS- 7 8 11 12						
			w/Auxiliary Contact	NH1Y-2111FS- 7 8 11 12						
			w/Alarm Contact	-						
Relay Trip Voltage Trip	1	Tab Terminal	Without	Without	NH1Y-1500- 9 11 12	-	-	100V AC 24V DC	Blank, A, C, D	Blank, R, G, W
	2			Without	NH1Y-2500- 9 11 12					
	-			-	-					

NH1 Series Circuit Protectors

NH1L (Rocker w/indicator)

Specify a rated current, time delay curve, rated voltage, indicator, rocker indicator, and rocker color in place of

7 8 9 10 11 12.

Package Quantity: 1

Internal Circuit	No. of Poles	Terminal Style	Inertia Delay	Auxiliary Contact Alarm Contact	Part No.	Designation Code					
						7 Rated Current	8 Time Delay Curve	9 Rated Voltage	10 Indicator	11 Rocker Indication	12 Rocker Color
Series Trip Current Trip	1	Tab Terminal	Without	Without	NH1L-1100- 7 8 10 11 12	0.5A 0.75A 1A 2A 3A 5A 7.5A 10A 15A 20A 25A 30A	AA BA MA AD MD	-	1: Neon 125V AC 50/60Hz 3: LED 6V AC/DC 4: LED 12V AC/DC 5: LED 24V AC/DC 7: LED 48V AC/DC	Blank, A, C, D	Blank, R, G, W
				w/Auxiliary Contact	NH1L-1111- 7 8 10 11 12						
				w/Alarm Contact	-						
		With	Without	NH1L-1100F- 7 8 10 11 12							
			w/Auxiliary Contact	NH1L-1111F- 7 8 10 11 12							
			w/Alarm Contact	-							
	Screw Terminal	Without	Without	NH1L-1100S- 7 8 10 11 12							
			w/Auxiliary Contact	NH1L-1111S- 7 8 10 11 12							
			w/Alarm Contact	-							
		With	Without	NH1L-1100FS- 7 8 10 11 12							
			w/Auxiliary Contact	NH1L-1111FS- 7 8 10 11 12							
			w/Alarm Contact	-							
Series Trip Current Trip	2	Tab Terminal	Without	Without	NH1L-2100- 7 8 10 11 12						
				w/Auxiliary Contact	NH1L-2111- 7 8 10 11 12						
				w/Alarm Contact	-						
		With	Without	NH1L-2100F- 7 8 10 11 12							
			w/Auxiliary Contact	NH1L-2111F- 7 8 10 11 12							
			w/Alarm Contact	-							
	Screw Terminal	Without	Without	NH1L-2100S- 7 8 10 11 12							
			w/Auxiliary Contact	NH1L-2111S- 7 8 10 11 12							
			w/Alarm Contact	-							
		With	Without	NH1L-2100FS- 7 8 10 11 12							
			w/Auxiliary Contact	NH1L-2111FS- 7 8 10 11 12							
			w/Alarm Contact	-							
Relay Trip Voltage Trip	1	Tab Terminal	Without	Without	NH1L-1500- 9 10 11 12	-	-	100V AC 24V DC	1: Neon 125V AC 50/60Hz 3: LED 6V AC/DC 4: LED 12V AC/DC 5: LED 24V AC/DC 7: LED 48V AC/DC	Blank, A, C, D	Blank, R, G, W
	2			Without	NH1L-2500- 9 10 11 12						
	-			-	-						

NH1 Series Circuit Protectors

NH1V (Lever)

Specify a rated current, time delay curve, and rated voltage in place of [7] [8] [9].

Package Quantity: 1

Internal Circuit	No. of Poles	Inertia Delay	Auxiliary Contact Alarm Contact	Part No.	Code for Ordering		
					[7] Rated Current	[8] Time Delay Curve	[9] Rated Voltage
Series Trip Current Trip	1	Without	Without	NH1V-1100- [7] [8]	0.5A 0.75A 1A 2A 3A 5A 7.5A 10A 15A 20A 25A 30A	AA BA MA AD MD	-
			w/Auxiliary Contact	NH1V-1111- [7] [8]			
			w/Alarm Contact	NH1V-1121- [7] [8]			
		With	Without	NH1V-1100F- [7] [8]			
			w/Auxiliary Contact	NH1V-1111F- [7] [8]			
			w/Alarm Contact	NH1V-1121F- [7] [8]			
	2	Without	Without	NH1V-2100- [7] [8]			
			w/Auxiliary Contact	NH1V-2111- [7] [8]			
			w/Alarm Contact	NH1V-2121- [7] [8]			
		With	Without	NH1V-2100F- [7] [8]			
			w/Auxiliary Contact	NH1V-2111F- [7] [8]			
			w/Alarm Contact	NH1V-2121F- [7] [8]			
	3	Without	Without	NH1V-3100- [7] [8]			
			w/Auxiliary Contact	NH1V-3111- [7] [8]			
			w/Alarm Contact	NH1V-3121- [7] [8]			
With		Without	NH1V-3100F- [7] [8]				
		w/Auxiliary Contact	NH1V-3111F- [7] [8]				
		w/Alarm Contact	NH1V-3121F- [7] [8]				
Relay Trip Voltage Trip	1	Without	Without	NH1V-1500- [9]	-	-	100V AC 24V DC
	2		Without	NH1V-2500- [9]			
	3		Without	NH1V-3500- [9]			

NH1 Series Circuit Protectors

Internal Circuits and Terminal Arrangements

Internal Circuit Model	Series Trip (Current Trip)	Series Trip (w/auxiliary contact)	Series Trip (w/alarm contact)	Relay Trip (Voltage Trip)	Dual Coil Series Trip + Relay Trip (Voltage Trip)												
NH1S																	
NH1Y			-		-												
NH1L w/indicator			-		-												
Shape (Rear View)																	
(Photo: NH1S)																	
<p>Note: The 2-pole with auxiliary or alarm contact has the contacts on the left side as viewed from the front. The 3-pole with auxiliary and alarm contacts has the contacts on the center. See the dimensional drawings for the terminal arrangement.</p> <p>• Wiring Example</p> <div style="display: flex; justify-content: space-between;"> <div style="width: 45%;"> </div> <div style="width: 45%;"> <p>• Lead Wires for Neon and LED Indicators:</p> <table border="1"> <thead> <tr> <th>Lead Wire</th> <th>Color</th> <th>Neon</th> <th>LED</th> </tr> </thead> <tbody> <tr> <td>Lead wire A</td> <td>Red</td> <td>AC</td> <td>Positive</td> </tr> <tr> <td>Lead wire B</td> <td>Black</td> <td>AC</td> <td>Negative</td> </tr> </tbody> </table> </div> </div>						Lead Wire	Color	Neon	LED	Lead wire A	Red	AC	Positive	Lead wire B	Black	AC	Negative
Lead Wire	Color	Neon	LED														
Lead wire A	Red	AC	Positive														
Lead wire B	Black	AC	Negative														

NH1V

Internal Circuit Model	Series Trip (Current Trip)	Series Trip (w/auxiliary contact)	Series Trip (w/alarm contact)	Relay Trip (Voltage Trip)
NH1V				
Shape				

Note: See the dimensional drawings for the terminal arrangement.

Overcurrent - Time Delay Characteristics (sec at 25°C) [at vertical mounting]

For	Time Delay Curve	Percent of Rated Current							
		100%	125%	150%	200%	400%	600%	800%	1000%
AC 50/60Hz	AA	No Trip	12-180	6-70	2-25	0.15-3.5	0.005-0.3	0.004-0.13	0.004-0.04
	BA	No Trip	0.7-15	0.3-4	0.1-1.3	0.02-0.25	0.006-0.13	0.003-0.07	0.003-0.04
	MA	No Trip	50-800	20-300	5.5-110	0.3-17	0.008-2.5	0.004-0.5	0.004-0.1
DC	AD	No Trip	10-180	6-75	2.6-30	0.5-7	0.015-3	0.004-0.8	0.003-0.1
	MD	No Trip	70-800	25-300	10-100	1.2-20	0.02-5	0.004-0.65	0.003-0.1

Note: Circuit protectors with inertia delay may have a slightly longer time delay at 400% or higher.

Dual Coil

For	Time Delay Curve	Percent of Rated Current							
		100%	125%	150%	200%	400%	600%	800%	1000%
AC 50/60Hz	AA	No trip	6-500	2-150	0.7-40	0.1-8	0.005-1.2	0.003-0.2	0.003-0.15
	BA	No trip	0.7-60	0.25-20	0.07-6	0.013-1.2	0.004-0.4	0.003-0.2	0.003-0.15
	MA	No trip	50-800	15-600	6-250	0.4-40	0.06-3	0.003-0.2	0.003-0.15
DC	AD	No trip	10-180	1.5-100	0.6-30	0.1-7	0.015-3	0.004-0.8	0.003-0.1
	MD	No trip	70-800	14-600	5-200	0.8-40	0.007-20	0.003-4	0.003-0.1

Note: Circuit protectors with inertia delay may have a slightly longer time delay at 400% or higher.

Time Delay Curves

Note: The dashed lines show dual coil.

For AC

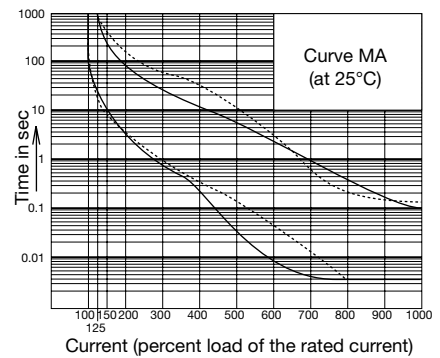
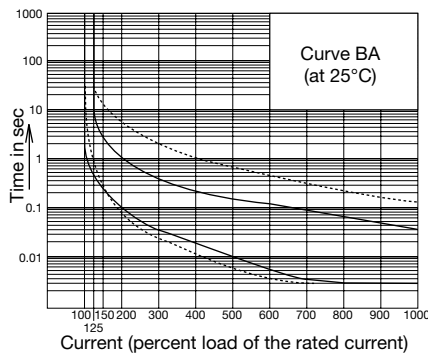
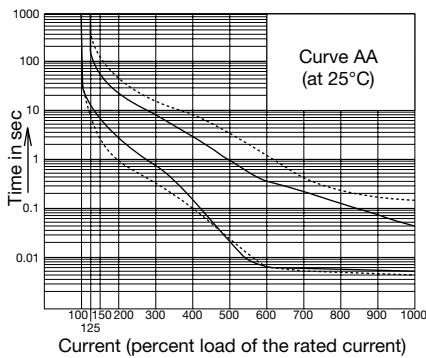

For DC

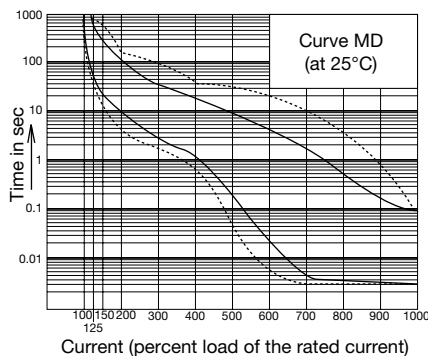
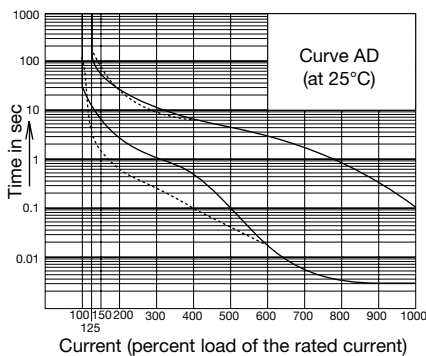

NH1 Series Circuit Protectors

Time Delay Curve and Ambient Temperature

Since NH1 series circuit protectors employ an electromagnetic tripping system, the rated current (trip current) is not affected by ambient temperatures but the time delay varies with the oil viscosity in the oil dash pot. Lower oil viscosity at higher temperatures results in shorter delay, whereas at lower temperatures the delay will be prolonged. The time delay curves on the preceding are at 25°C. With reference to these curves, time delays can be corrected.

Temperature Correction Curve

The time delay curves are at 25°C. With reference to the following figure, time delays can be corrected.

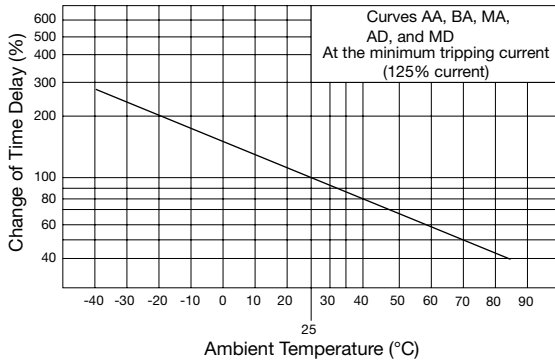

Circuit Protector with Inertia Delay

1. Circuit protectors equipped with inertia delay do not respond to high inrush currents caused by transformer or lamp loads, but perform the specified interruption on the subsequent overcurrents.
2. Inertia delay is designed not to trip on a pulse of 1500% the rated current for a duration of 10 ms.

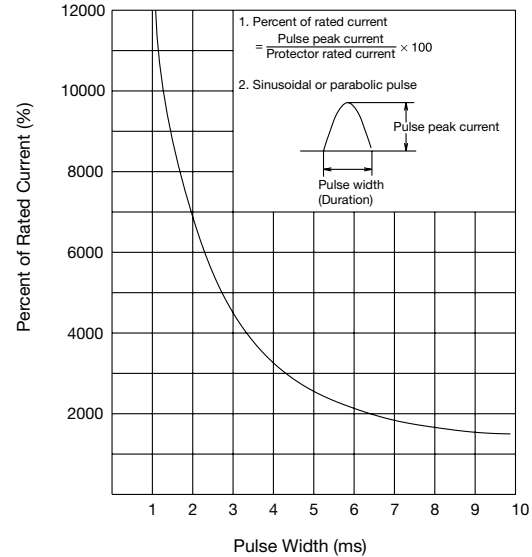

Impedance and Coil Resistance

Series Trip

[Current Trip]

Rated Current	For AC 50/60Hz Impedance (Ω)	For DC Resistance (Ω)	Rated Current	For AC 50/60Hz Impedance (Ω)	For DC Resistance (Ω)
	Curves AA, BA, and MA	Curves AD and MD		Curves AA, BA, and MA	Curves AD and MD
0.5A	3.36	3.24	7.5A	0.018	0.017
0.75A	1.49	1.45	10A	0.012	0.012
1A	0.92	0.90	15A	0.0068	0.0066
2A	0.21	0.21	20A	0.0048	0.0048
2.5A	0.13	0.13	25A	0.0043	0.0043
3A	0.092	0.09	30A	0.0041	0.0036
5A	0.036	0.036			

Note: Tolerance: ±25% (up to 5A), ±50% (7.5A or higher)

Relay Trip

[Voltage Trip]

Rated Voltage	For AC 50/60Hz Impedance (Ω)	For DC Resistance (Ω)
100V AC	1350	-
24V DC	-	248

Dual Coil

[Current Trip]

Rated Current	For AC 50/60Hz Impedance (Ω)	For DC Resistance (Ω)
	Curves AA, BA, and MA	Curves AD and MD
2A	0.308	0.307
3A	0.129	0.127
5A	0.0509	0.0518
7.5A	0.0249	0.0245
10A	0.0150	0.0150
15A	0.0084	0.0080

Note: Tolerance: ±25% (up to 5A), ±50% (7.5A or higher)

[Voltage Trip]

Rated Voltage	For AC 50/60Hz Impedance (Ω)	For DC Resistance (Ω)
100V AC	321	-
24V DC	-	15.7

Note: Tolerance: ±25%

Voltage Drop Due to Coil Resistance or Impedance

The internal resistance or impedance of a circuit protector tends to be larger for a smaller rated current. Therefore, when circuit protectors of a small rated current are used, voltage drop should be taken into consideration. Internal resistance also varies with time delay curves in spite of the same rated current, which should also be considered during installation.

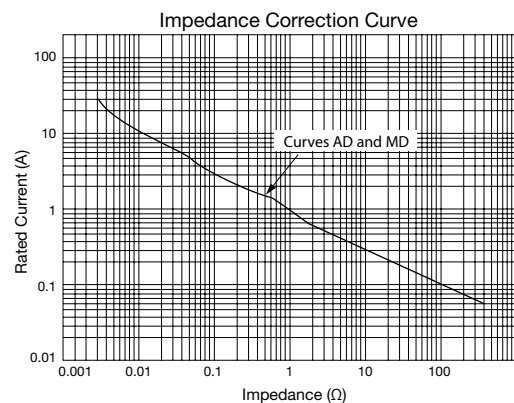
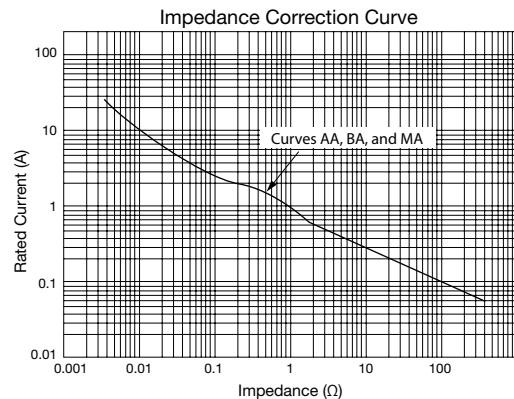

NH1 Series Circuit Protectors

Dimensions

NH1S
1-pole

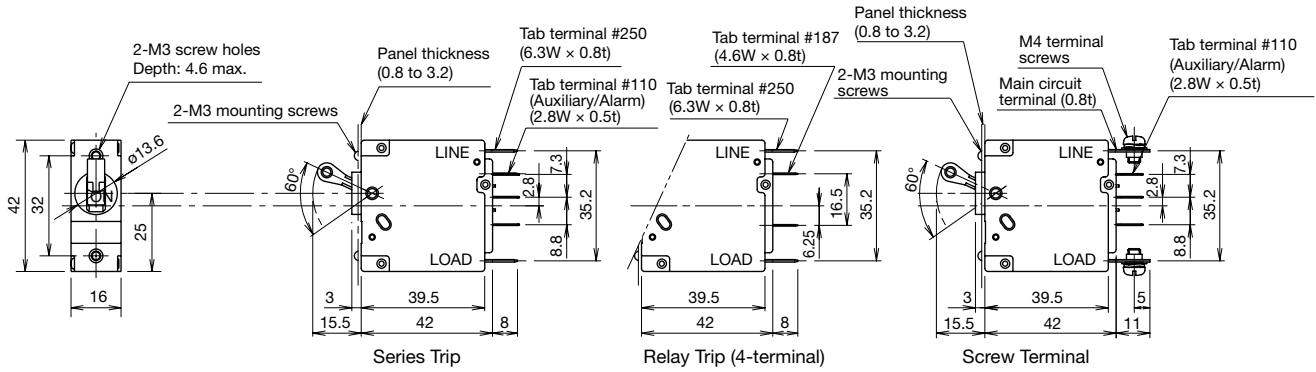

2-pole

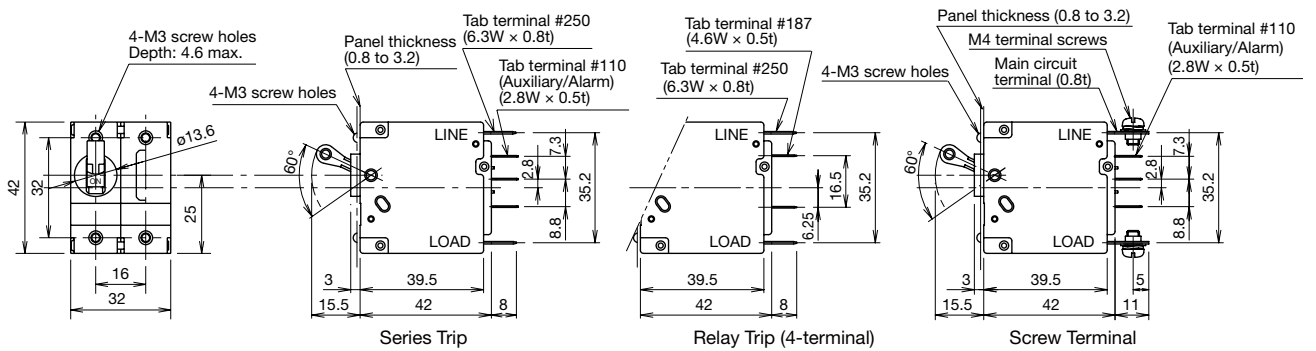

3-pole

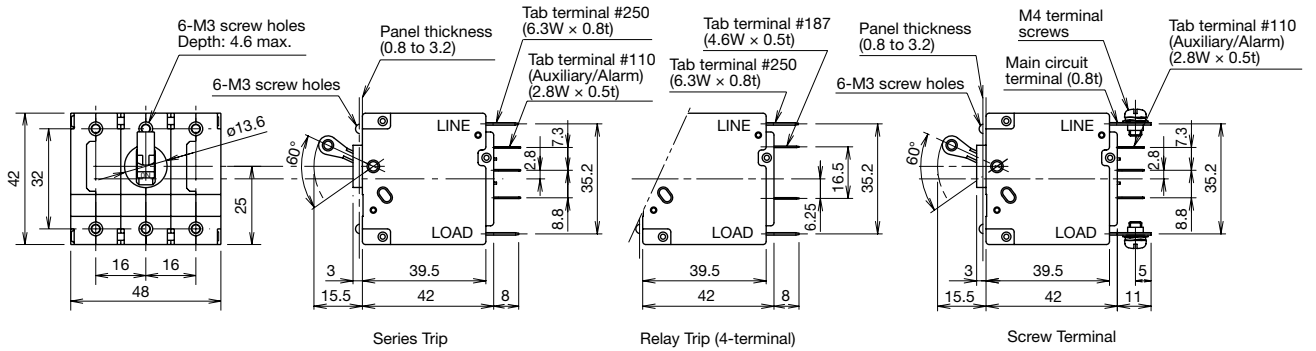

NH1Y • NH1L

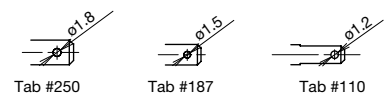
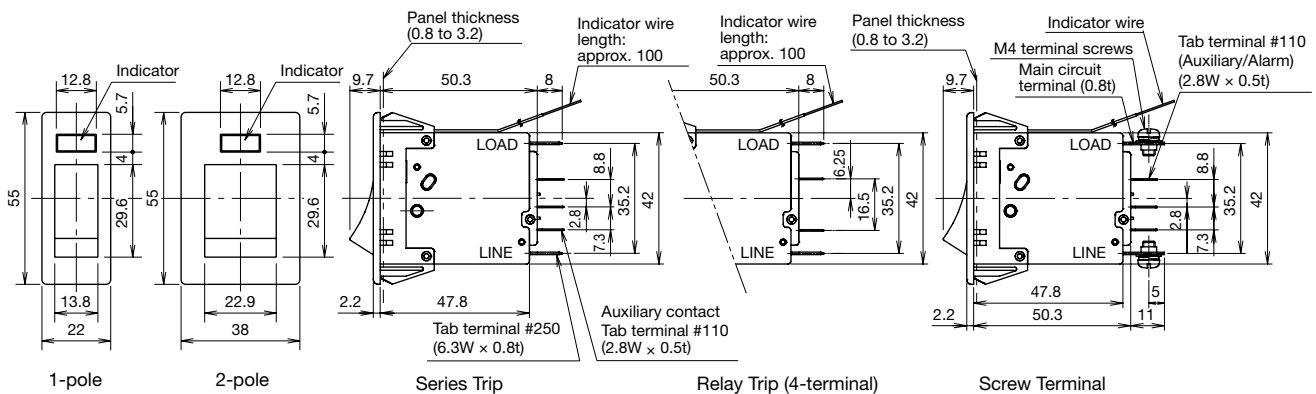

All dimensions in mm.

NH1 Series Circuit Protectors (Accessories)

Dimensions

NH1V
1-pole

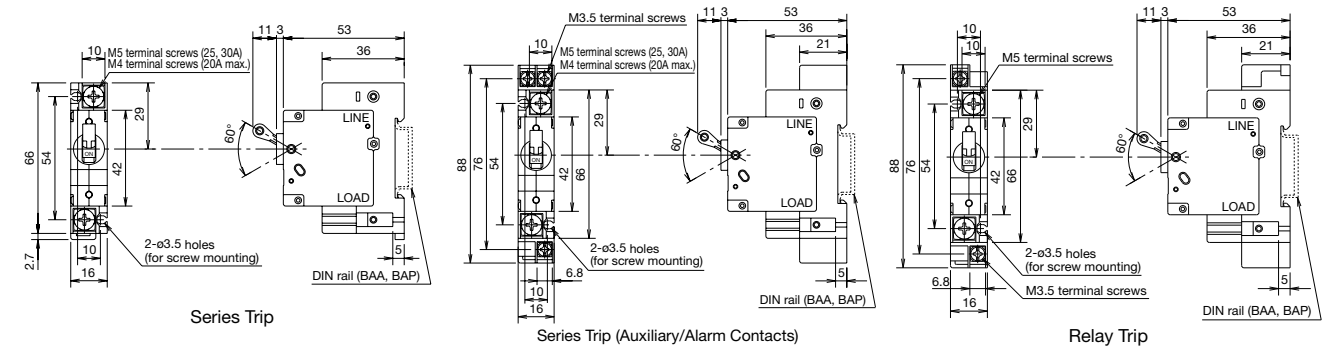

2-pole

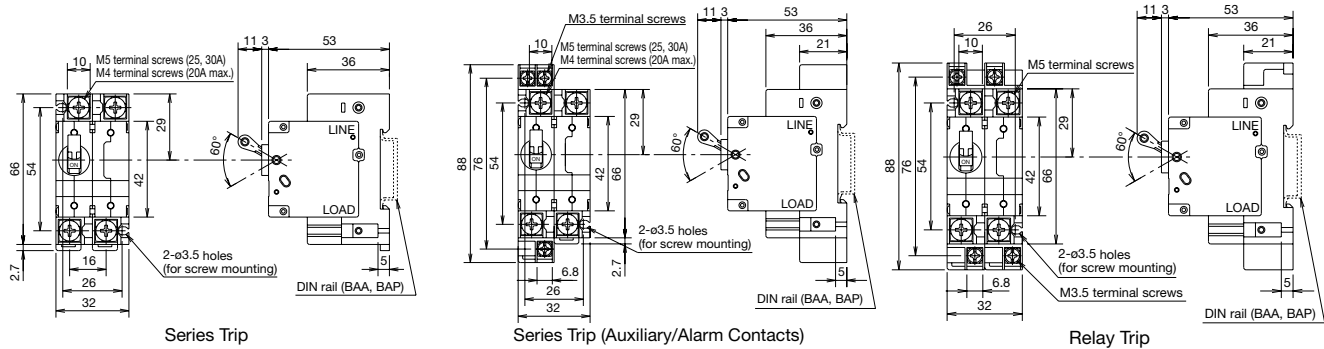

3-pole

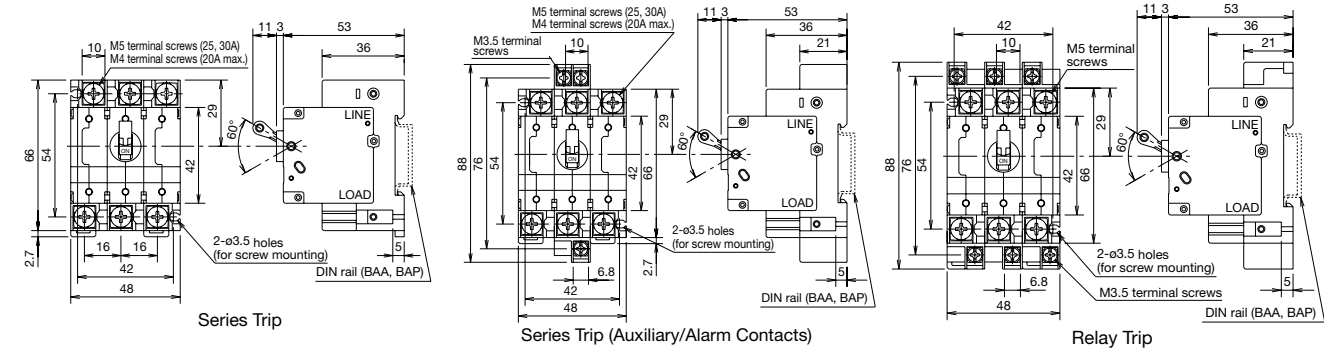

Accessories

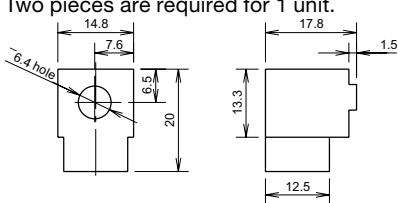
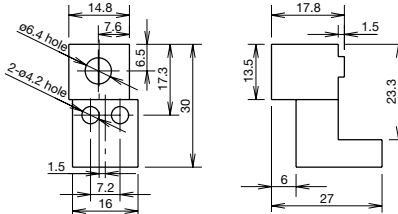
Product / Shape	Part No.	Ordering No.	Package Quantity	Description / Dimensions
Terminal Cover (for main terminals) for NH1V  Material: Polyamide	NH9Z-A	NH9Z-APN02	2	Two pieces are required for 1 unit. 
Terminal Cover (for main/auxiliary terminals) for NH1V  Material: Polyamide	NH9Z-B	NH9Z-BPN02	2	Two pieces are required for 1 unit. 

NH1 Series Circuit Protectors Instructions

Mounting Hole Layout

NH1S

1-pole

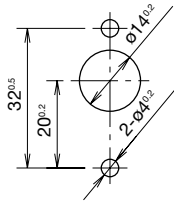

2-pole

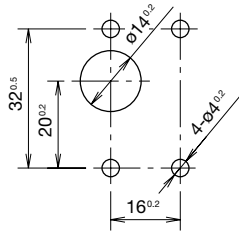

3-pole

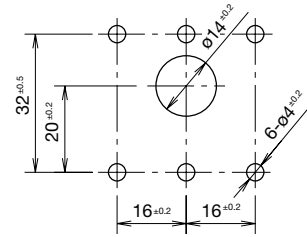

NH1Y • NH1L

1-pole

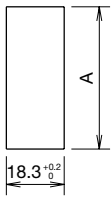

2-pole

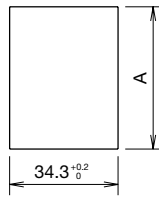

- Determine the dimension A within the panel thickness using the following formula:
 $\text{Dimension A (mm)} = 50.4 + (\text{Panel thickness} - 0.8) \times 0.87$
 Applicable panel thickness: 0.8 to 3.2 mm

Panel Mounting Screw Length

Select the screw length with reference to the following table.

Panel thickness (mm)	0.8	1.0	1.2	1.4	1.6	1.8	2.0	2.3	2.6	3.2
Without washer	5	5	5	6	6	6	6	6	7	7
With plain washer (0.5 mm thick)	5	6	6	6	6	6	7	7	7	8
With spring washer (0.7 mm thick)	6	6	6	6	6	7	7	7	7	8
With plain washer (0.5 mm thick) and spring washer (0.7 mm thick)	6	6	7	7	7	7	7	8	8	8

M3 screw mounting
 Tightening torque: 0.5 to 0.8 N·m minimum

NH1V

1-pole

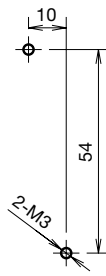

2-pole

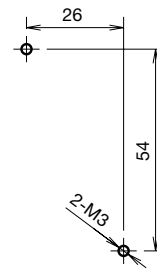

3-pole

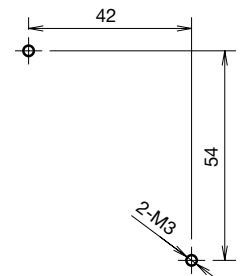

Installation Angle

Tripping method is hydraulic magnetic. Minimum operating current varies with installation angle because operating currents are influenced by the weight of movable iron core. With reference to the following figure, correct the rated current.

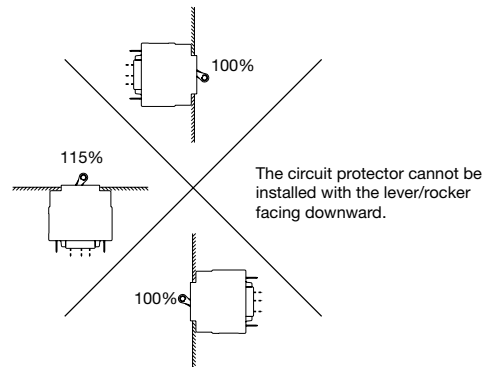

Note 1: The rated current does not change depending on the installation angle.

Note 2: The minimum operating current is calculated from the following formula:
 (Minimum operating current) = (Rated current) × 125% × (Correction factor by installation angle)

Instructions

One-pole circuit protectors cannot be combined to make 2- or 3-pole units due to their characteristics. Order multi-poles from IDEC.

Recommended Soldering Conditions

Solder the main terminal at a temperature of 390°C within 10 seconds using a 60W soldering iron.

Solder the auxiliary/alarm terminal at a temperature of 350°C within 3 seconds using a 60W soldering iron. (Sn-Ag-Cu lead-free solder is recommended.)

When soldering, do not touch the circuit protector housing, auxiliary and alarm contacts with the soldering iron, and do not bend the terminals or pull the wires.

Check your actual soldering conditions before soldering.

Main Circuit Terminal: Screw terminal

Applicable wire size	1.25 to 5.5 mm ²
Applicable crimping terminal	R1.25-4 to R5.5-4
No. of crimping terminal	1
Tightening torque	1.0 to 1.2 N·m

Thrust force (screw pressing load) in screw tightening should be 29N or less. The screw driver may slip out depending on the shape and conditions. In this case, hold the terminal with a tool and tighten the screw by applying a thrust force of about 50N without deforming the terminal.

NRA series Circuit Protectors

Best Selling Circuit Protectors Wide selection of applications ranging from computers to office and factory automation

- Available with inertia delay
- Available with auxiliary contact or alarm contact
- Hydraulic-magnetic tripping system
- Safe trip-free mechanism
- Vibration-proof design
- Variety of mounting methods
- IEC (IEC 60934) compliant
- Available in tab-terminal and screw-terminal suited for crimping-terminal wiring.

Applicable Standards	Mark	Certification Organization / File No.
UL1077 CSA C22.2 No. 235 (Note 1)		UL/c-UL recognized File No. E68029
EN60934 (VDE0642) (Note 2)		VDE No. 116381
EN60934		EU Low Voltage Directive (Note 3)
GB17701		CCC No. 2005010309151792
Electrical Appliance and Material Safety Law Technical Standard		JET

For details, see the list of standard certified products in the back of this catalog.
Note 1: All standard models Note 2: All models Note 3: Series trip only

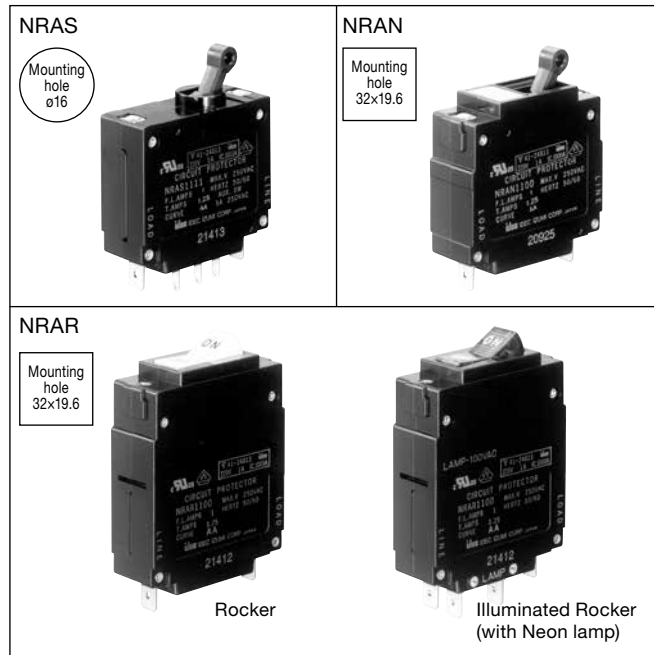

Specifications

Model	NRAS	NRAN	NRAR
Operator Style	Lever	Lever	Rocker (Non-illuminated, Illuminated)
Protection Method	Hydraulic-magnetic tripping system		
Internal Circuit	Series trip (current trip) Relay trip (voltage trip) Series trip (current trip) with auxiliary contacts Series trip (current trip) with alarm contacts		
No. of poles	1, 2, 3 poles	1 pole	
Rated Voltage	250V AC 50/60Hz, 65V DC		
Minimum Applicable Load	24V AC/DC, 100 mA (reference value)		
Rated Current	Current trip: 0.3A, 0.5A, 0.75A, 1A, 2A, 3A, 5A, 7.5A, 10A, 15A, 20A, 25A, 30A		
Trip Voltage (Voltage trip)	Rated voltage: 24V DC (operating at 90% of the rated voltage or higher, at 25°C) Voltage application duration: 1 sec maximum Trip time: 0.05 sec maximum (at the rated voltage)		
Rated Interrupting Current	250V AC 50/60Hz 1000A, 65V DC 1000A		
Auxiliary Contact Alarm Contact	SPDT microswitch 250V AC 5A (resistive load), 50V DC 1A (resistive load)		
Reference Temperature	+25°C		
Operating Temperature	-40 to +85°C (no freezing)		
Storage Temperature	-40 to +90°C (no freezing)		
Operating Humidity	45 to 85% RH (no condensation)		
Storage Humidity	45 to 85% RH (no condensation)		
Insulation Resistance	100 MΩ minimum (500V DC megger)		
Dielectric Strength	2000V AC for 1 minute (between live part and ground, between terminals of different poles, between terminals of the same poles when main contacts are open, between main circuit and auxiliary contact)		
Vibration Resistance	100 m/s ² (10 to 100Hz)		
Shock Resistance	1000 m/s ²		
Life	Over 10,000 operations (6 operations per minute)		
Terminal Style	Main terminal: Tab terminal #250, M4 screw terminal Auxiliary contact/Alarm contact: Tab terminal #110		
Weight (Approx.) (NRAS series trip)	1-pole: 60g, 2-pole: 125g, 3-pole: 190g		

- Do not use the NRA circuit protectors in environments where they are exposed to extreme temperature, humidity, dust, corrosive gases, vibration, shock, or in a circuit where inrush current may be present, otherwise unnecessary operations and damage may occur.

Indicator Ratings (Illuminated rocker unit)

Indicator	Rated Voltage
Neon	100 to 110V AC, 50/60Hz 200 to 220V AC, 50/60Hz
LED	4 to 8V DC

Standard Color

Housing	Black		
Lever (NRAS-, NRAN)	Black with white letters, ON-OFF, I/O		
Rocker Color, Indicator Color (NRAR)	Non-illuminated	Rocker Color	Indicator Color
	with Neon lamp	Opaque white	-
		Transparent red	Red

NRA Series Circuit Protectors

Part No. Development

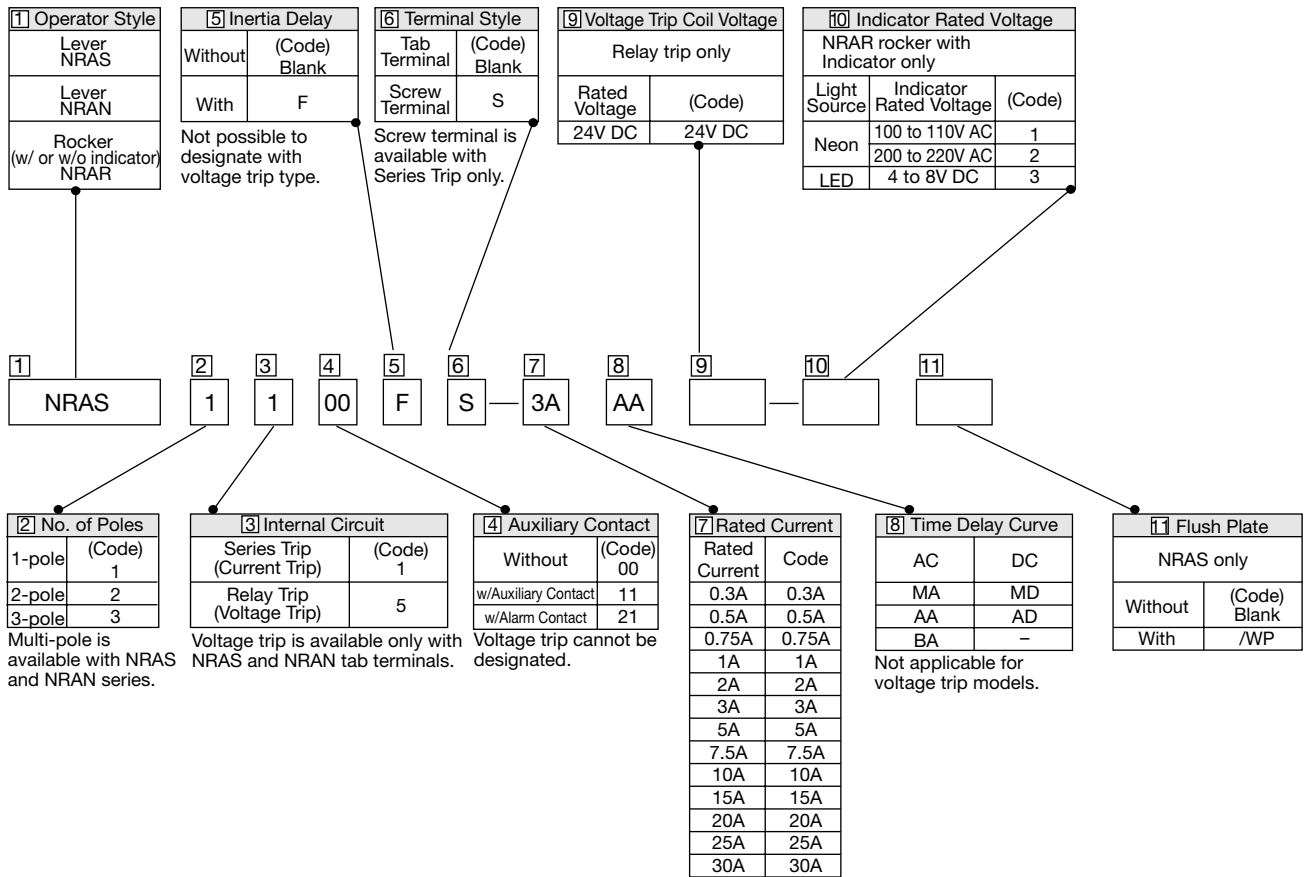

Part No. Examples

(1) Circuit protector: Lever

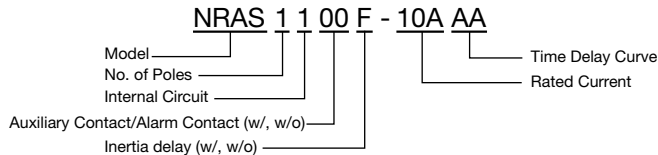

(2) Circuit Protector: Illuminated rocker

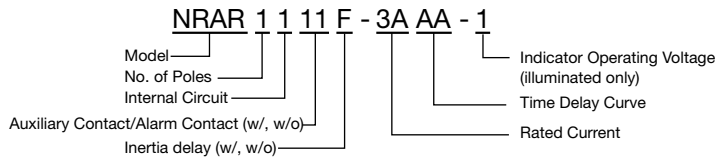

NRA Series Circuit Protectors

NRAS (Lever)

Specify a rated current, time delay curve, and rated voltage in place of [7] [8] [9].

Package Quantity: 1

Internal Circuit	No. of Poles	Terminal Style	Inertia Delay	Flush Plate	Auxiliary Contact Alarm Contact	Part No.	Designation Code			
							[7] Rated Current	[8] Time Delay Curve	[9] Rated Voltage	
Series Trip Current Trip	1	Tab Terminal	Without	Without	Without	NRAS1100- [7] [8]	0.3A 0.5A 0.75A 1A 2A 3A 5A 7.5A 10A 15A 20A 25A 30A	AA BA MA AD MD	-	
					w/Auxiliary Contact	NRAS1111- [7] [8]				
					w/Alarm Contact	NRAS1121- [7] [8]				
			With	Without	Without	NRAS1100- [7] [8] /WP				
					w/Auxiliary Contact	NRAS1111- [7] [8] /WP				
					w/Alarm Contact	NRAS1121- [7] [8] /WP				
		With	Without	Without	Without	NRAS1100F- [7] [8]				
					w/Auxiliary Contact	NRAS1111F- [7] [8]				
					w/Alarm Contact	NRAS1121F- [7] [8]				
			With	Without	Without	Without				NRAS1100F- [7] [8] /WP
						w/Auxiliary Contact				NRAS1111F- [7] [8] /WP
						w/Alarm Contact				NRAS1121F- [7] [8] /WP
	Screw Terminal	Without	Without	Without	Without	NRAS1100S- [7] [8]				
					w/Auxiliary Contact	NRAS1111S- [7] [8]				
					w/Alarm Contact	NRAS1121S- [7] [8]				
			With	Without	Without	Without	NRAS1100S- [7] [8] /WP			
						w/Auxiliary Contact	NRAS1111S- [7] [8] /WP			
						w/Alarm Contact	NRAS1121S- [7] [8] /WP			
		With	Without	Without	Without	Without	NRAS1100FS- [7] [8]			
						w/Auxiliary Contact	NRAS1111FS- [7] [8]			
						w/Alarm Contact	NRAS1121FS- [7] [8]			
			With	Without	Without	Without	NRAS1100FS- [7] [8] /WP			
						w/Auxiliary Contact	NRAS1111FS- [7] [8] /WP			
						w/Alarm Contact	NRAS1121FS- [7] [8] /WP			
Series Trip Current Trip	2	Tab Terminal	Without	Without	Without	NRAS2100- [7] [8]	0.3A 0.5A 0.75A 1A 2A 3A 5A 7.5A 10A 15A 20A 25A 30A	AA BA MA AD MD	-	
					w/Auxiliary Contact	NRAS2111- [7] [8]				
					w/Alarm Contact	NRAS2121- [7] [8]				
			With	Without	Without	Without				NRAS2100- [7] [8] /WP
						w/Auxiliary Contact				NRAS2111- [7] [8] /WP
						w/Alarm Contact				NRAS2121- [7] [8] /WP
		With	Without	Without	Without	Without				NRAS2100F- [7] [8]
						w/Auxiliary Contact				NRAS2111F- [7] [8]
						w/Alarm Contact				NRAS2121F- [7] [8]
			With	Without	Without	Without				NRAS2100F- [7] [8] /WP
						w/Auxiliary Contact				NRAS2111F- [7] [8] /WP
						w/Alarm Contact				NRAS2121F- [7] [8] /WP
	Screw Terminal	Without	Without	Without	Without	NRAS2100S- [7] [8]				
					w/Auxiliary Contact	NRAS2111S- [7] [8]				
					w/Alarm Contact	NRAS2121S- [7] [8]				
			With	Without	Without	Without	NRAS2100S- [7] [8] /WP			
						w/Auxiliary Contact	NRAS2111S- [7] [8] /WP			
						w/Alarm Contact	NRAS2121S- [7] [8] /WP			
		With	Without	Without	Without	Without	NRAS2100FS- [7] [8]			
						w/Auxiliary Contact	NRAS2111FS- [7] [8]			
						w/Alarm Contact	NRAS2121FS- [7] [8]			
			With	Without	Without	Without	NRAS2100FS- [7] [8] /WP			
						w/Auxiliary Contact	NRAS2111FS- [7] [8] /WP			
						w/Alarm Contact	NRAS2121FS- [7] [8] /WP			

NRA Series Circuit Protectors

NRAS (Lever)

Specify a rated current, time delay curve, and rated voltage in place of [7] [8] [9].

Package Quantity: 1

Internal Circuit	No. of Poles	Terminal Style	Inertia Delay	Flush Plate	Auxiliary Contact Alarm Contact	Part No.	Designation Code		
							[7] Rated Current	[8] Time Delay Curve	[9] Rated Voltage
Series Trip Current Trip	3	Tab Terminal	Without	Without	Without	NRAS3100- [7] [8]	0.3A 0.5A 0.75A 1A 2A 3A 5A 7.5A 10A 15A 20A 25A 30A	AA BA MA AD MD	-
					w/Auxiliary Contact	NRAS3111- [7] [8]			
					w/Alarm Contact	NRAS3121- [7] [8]			
			With	Without	Without	NRAS3100F- [7] [8]			
					w/Auxiliary Contact	NRAS3111F- [7] [8]			
					w/Alarm Contact	NRAS3121F- [7] [8]			
		Screw Terminal	Without	Without	Without	NRAS3100S- [7] [8]			
					w/Auxiliary Contact	NRAS3111S- [7] [8]			
					w/Alarm Contact	NRAS3121S- [7] [8]			
			With	Without	Without	NRAS3100FS- [7] [8]			
					w/Auxiliary Contact	NRAS3111FS- [7] [8]			
					w/Alarm Contact	NRAS3121FS- [7] [8]			
Relay Trip Voltage Trip	1	Tab Terminal	Without	Without	Without	NRAS1500- [9]	-	-	24V DC
	2				Without	NRAS2500- [9]			
	3				Without	NRAS3500- [9]			

NRA Series Circuit Protectors

NRAN (Lever)

Specify a rated current, time delay curve, and rated voltage in place of [7] [8] [9].

Package Quantity: 1

Internal Circuit	No. of Poles	Terminal Style	Inertia Delay	Auxiliary Contact Alarm Contact	Part No.	Designation Code		
						[7] Rated Current	[8] Time Delay Curve	[9] Rated Voltage
Series Trip Current Trip	1	Tab Terminal	Without	Without	NRAN1100- [7] [8]			
				w/Auxiliary Contact	NRAN1111- [7] [8]			
				w/Alarm Contact	NRAN1121- [7] [8]			
		With	Without	NRAN1100F- [7] [8]				
			w/Auxiliary Contact	NRAN1111F- [7] [8]				
			w/Alarm Contact	NRAN1121F- [7] [8]				
	Screw Terminal	Without	Without	NRAN1100S- [7] [8]				
			w/Auxiliary Contact	NRAN1111S- [7] [8]				
			w/Alarm Contact	NRAN1121S- [7] [8]				
		With	Without	NRAN1100FS- [7] [8]				
			w/Auxiliary Contact	NRAN1111FS- [7] [8]				
			w/Alarm Contact	NRAN1121FS- [7] [8]				
Series Trip Current Trip	2	Tab Terminal	Without	Without	NRAN2100- [7] [8]	0.3A 0.5A 0.75A 1A 2A 3A 5A 7.5A 10A 15A 20A 25A 30A	AA BA MA AD MD	-
				w/Auxiliary Contact	NRAN2111- [7] [8]			
				w/Alarm Contact	NRAN2121- [7] [8]			
		With	Without	NRAN2100F- [7] [8]				
			w/Auxiliary Contact	NRAN2111F- [7] [8]				
			w/Alarm Contact	NRAN2121F- [7] [8]				
	Screw terminal	Without	Without	NRAN2100S- [7] [8]				
			w/Auxiliary Contact	NRAN2111S- [7] [8]				
			w/Alarm Contact	NRAN2121S- [7] [8]				
		With	Without	NRAN2100FS- [7] [8]				
			w/Auxiliary Contact	NRAN2111FS- [7] [8]				
			w/Alarm Contact	NRAN2121FS- [7] [8]				
Series Trip Current Trip	3	Tab terminal	Without	Without	NRAN3100- [7] [8]			
				w/Auxiliary Contact	NRAN3111- [7] [8]			
				w/Alarm Contact	NRAN3121- [7] [8]			
		With	Without	NRAN3100F- [7] [8]				
			w/Auxiliary Contact	NRAN3111F- [7] [8]				
			w/Alarm Contact	NRAN3121F- [7] [8]				
	Screw Terminal	Without	Without	NRAN3100S- [7] [8]				
			w/Auxiliary Contact	NRAN3111S- [7] [8]				
			w/Alarm Contact	NRAN3121S- [7] [8]				
		With	Without	NRAN3100FS- [7] [8]				
			w/Auxiliary Contact	NRAN3111FS- [7] [8]				
			w/Alarm Contact	NRAN3121FS- [7] [8]				
Relay Trip Voltage Trip	1	Tab Terminal	Without	Without	NRAN1500- [9]	-	-	24V DC
	2			Without	NRAN2500- [9]			
	3			Without	NRAN3500- [9]			

NRA Series Circuit Protectors

NRAR (Rocker)

Specify a rated current, time delay curve, and indicator rated voltage in place of [7] [8] [10].

Package Quantity: 1

Illuminated	Internal Circuit	No. of Poles	Terminal Style	Inertia Delay	Auxiliary Contact Alarm Contact	Part No.	Designation Code					
							[7] Rated Current	[8] Time Delay Curve	[10] Indicator Rated Voltage			
Illuminated	Series Trip Current Trip	1	Tab Terminal	Without	Without	NRAR1000- [7] [8] - [10]	0.3A 0.5A 0.75A 1A 2A 3A 5A 7.5A 10A 15A 20A 25A 30A	AA BA MA AD MD	1: Neon 100 to 110V AC 2: Neon 200 to 220V AC 3: LED 4 to 8V DC			
					w/Auxiliary Contact	NRAR1111- [7] [8] - [10]						
					w/Alarm Contact	NRAR1121- [7] [8] - [10]						
				With	Without	NRAR1100F- [7] [8] - [10]						
					w/Auxiliary Contact	NRAR1111F- [7] [8] - [10]						
					w/Alarm Contact	NRAR1121F- [7] [8] - [10]						
			Screw Terminal	Without	Without	NRAR1100S- [7] [8] - [10]						
					w/Auxiliary Contact	NRAR1111S- [7] [8] - [10]						
					w/Alarm Contact	NRAR1121S- [7] [8] - [10]						
				With	Without	NRAR1100FS- [7] [8] - [10]						
					w/Auxiliary Contact	NRAR1111FS- [7] [8] - [10]						
					w/Alarm Contact	NRAR1121FS- [7] [8] - [10]						
			Non-illuminated	Series Trip Current Trip	1	Tab Terminal	Without	Without	NRAR1100- [7] [8]	0.3A 0.5A 0.75A 1A 2A 3A 5A 7.5A 10A 15A 20A 25A 30A	AA BA MA AD MD	-
								w/Auxiliary Contact	NRAR1111- [7] [8]			
								w/Alarm Contact	NRAR1121- [7] [8]			
							With	Without	NRAR1100F- [7] [8]			
w/Auxiliary Contact	NRAR1111F- [7] [8]											
w/Alarm Contact	NRAR1121F- [7] [8]											
Screw Terminal	Without	Without				NRAR1100S- [7] [8]						
		w/Auxiliary Contact				NRAR1111S- [7] [8]						
		w/Alarm Contact				NRAR1121S- [7] [8]						
	With	Without				NRAR1100FS- [7] [8]						
		w/Auxiliary Contact				NRAR1111FS- [7] [8]						
		w/Alarm Contact				NRAR1121FS- [7] [8]						

NRA Series Circuit Protectors

Internal Circuits

NRAS and NRAN

Series Trip (Current Trip)	Series Trip (Current Trip) With Auxiliary Contact	Series Trip (Current Trip) With Alarm Contact	Relay Trip (Voltage Trip)	

NRAR • Dashed lines show the illuminated rocker type.

Series Trip (Current Trip)	Series Trip (Current Trip) With Auxiliary Contact	Series Trip (Current Trip) With Alarm Contact	-	
			-	

- Indicator terminals on the illuminated rocker type
Indicator terminals are available only on the series trip type without auxiliary and alarm contacts.
Auxiliary and alarm contacts are provided with color-coded lead wires as shown in the table at right.

• Wiring Example

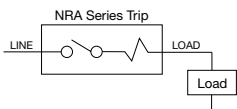

Indicator		Lead Wire	
		A	B
Neon (for AC)	100 to 110V	White	White
	200 to 220V	Black	Black
LED (for DC)	Positive	Black	-
	Negative	-	White

Overcurrent - Time Delay Characteristics (sec at 25°C)

For	Time Delay Curve	Percent of Rated Current							
		100%	125%	150%	200%	400%	600%	800%	1000%
AC 50/60Hz	AA	No Trip	10-120	6-45	2.2-15	0.3-2	0.05-0.55	0.007-0.13	0.005-0.04
	BA	No Trip	0.75-10	0.45-3.5	0.22-1.3	0.045-0.22	0.012-0.12	0.005-0.06	0.004-0.03
	MA	No Trip	60-900	30-260	9-70	1.5-8	0.18-2.5	0.009-0.25	0.006-0.08
DC	AD	No Trip	10-130	6-55	2.6-20	0.5-3.5	0.12-1.4	0.008-0.1	0.005-0.05
	MD	No Trip	35-400	20-200	7-60	1.3-8	0.2-3	0.01-0.25	0.006-0.08

Note: Circuit protectors with inertia delay may have a slightly longer time delay at 600% or higher.

Time Delay Curves

For AC

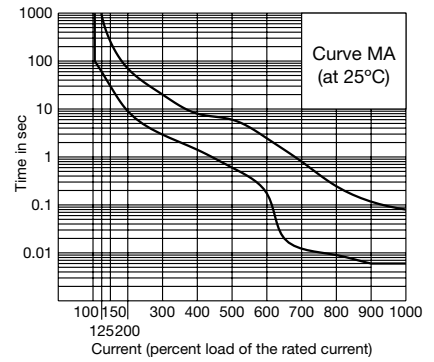
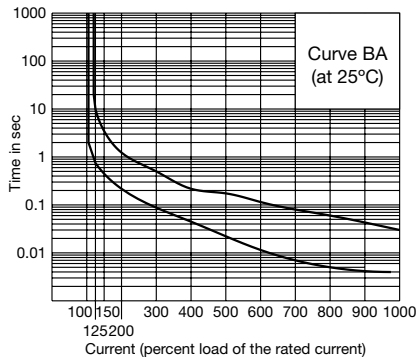
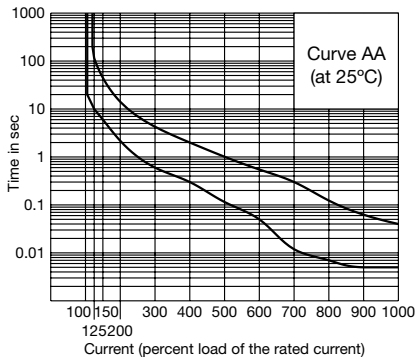

For DC

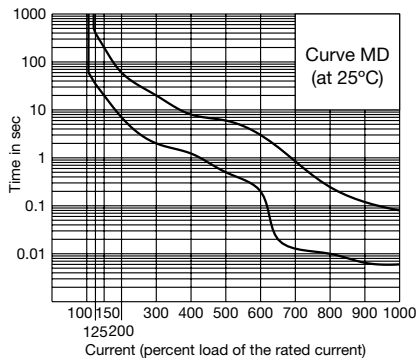
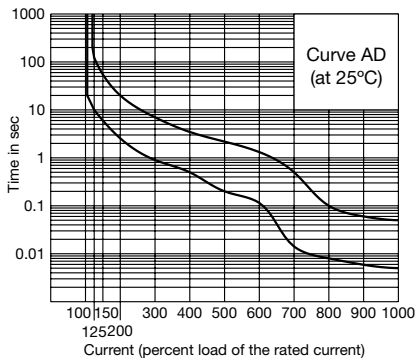

Time Delay Curve and Ambient Temperature

Since the NRA series circuit protectors employ an electromagnetic tripping system, the rated current (trip current) is not affected by the ambient temperatures, but the time delay varies with the oil viscosity in the oil dash pot. Lower oil viscosity at higher temperatures results in shorter delay, whereas at lower temperatures the delay will be prolonged.

The above time delay curves are at 25°C. With reference to these curves, time delays can be corrected.

Temperature Correction Curve

The above time delay curves are at 25°C. With reference to the following figure, time delays can be corrected.

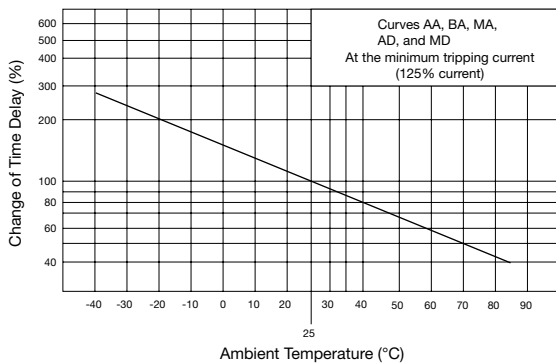

Circuit Protector with Inertia Delay

Circuit protectors equipped with inertia delay do not respond to high inrush currents caused by transformer or lamp loads, but perform the specified interruption on the subsequent overcurrents.

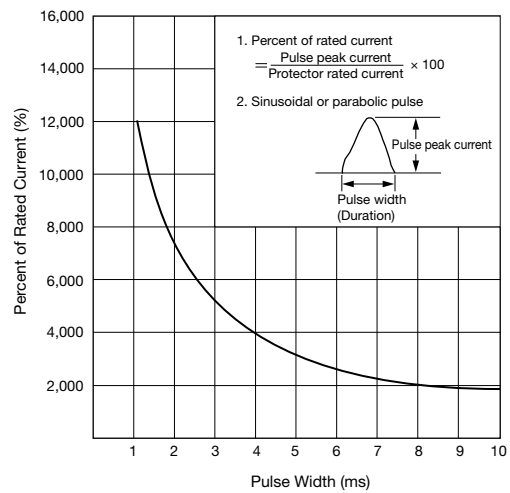

Note: Inertia delay is designed not to trip on a pulse of 20 times the rated current (peak value) for a duration of 8 ms. See the above curve.

All dimensions in mm.

NRA Series Circuit Protectors

Impedance and Coil Resistance

Series Trip (Current Trip) (at 25°C)

Rated Current	Current Trip	
	For AC 50/60Hz Impedance (Ω)	For DC Resistance (Ω)
	Curves AA, BA, and MA	Curves AD and MD
0.3A	9.82	9.67
0.5A	3.36	3.24
0.75A	1.49	1.45
1A	0.92	0.90
2A	0.21	0.21
3A	0.092	0.09
5A	0.036	0.036
7.5A	0.018	0.017
10A	0.012	0.0012
15A	0.0068	0.0066
20A	0.0048	0.0048
25A	0.0043	0.0043
30A	0.0041	0.0036

Note: Tolerance: $\pm 25\%$ (up to 5A), $\pm 50\%$ (7.5A or higher)

Relay Trip (Voltage Trip) (at 25°C)

Rated Voltage	For DC Resistance (Ω)
24V DC	163

Note: Tolerance: $\pm 25\%$

Voltage Drop due to Coil Resistance or Impedance

The internal resistance or impedance of a circuit protector tends to be larger for a smaller rated current. Therefore, when circuit protectors of a small rated current are used for a power-supply switch, voltage drop should be taken into consideration. Internal resistance also varies with time delay curves in spite of the same rated current, which should also be considered during installation.

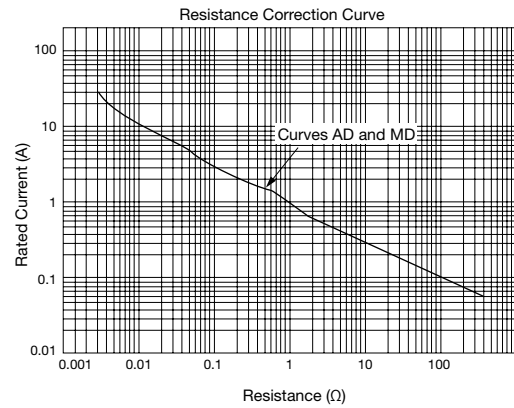
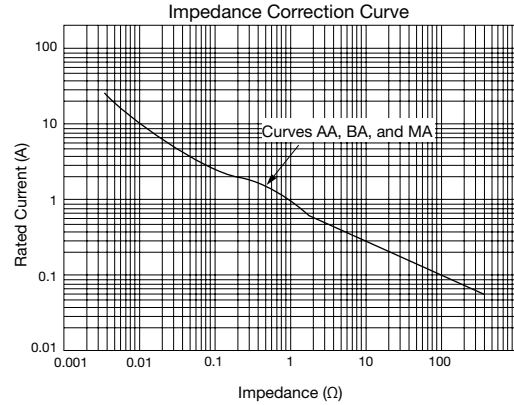

Dimensions

NRAS (Lever)

1-pole

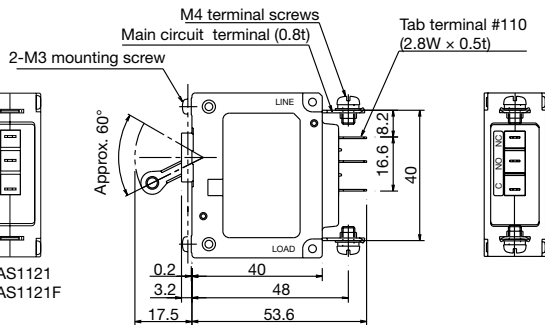
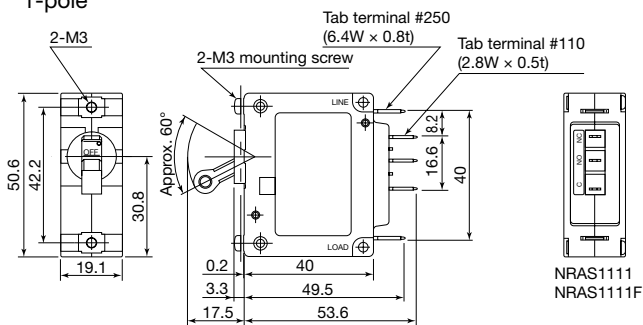

2-pole

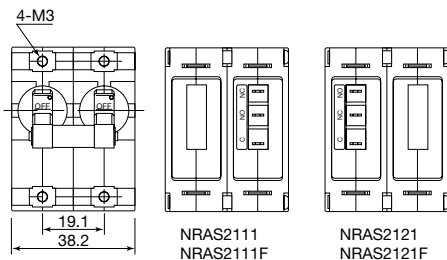

3-pole

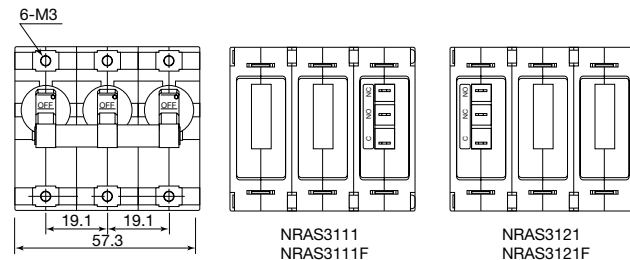

All dimensions in mm.

NRA Series Circuit Protectors

NRAS (Lever with Flush Plate)

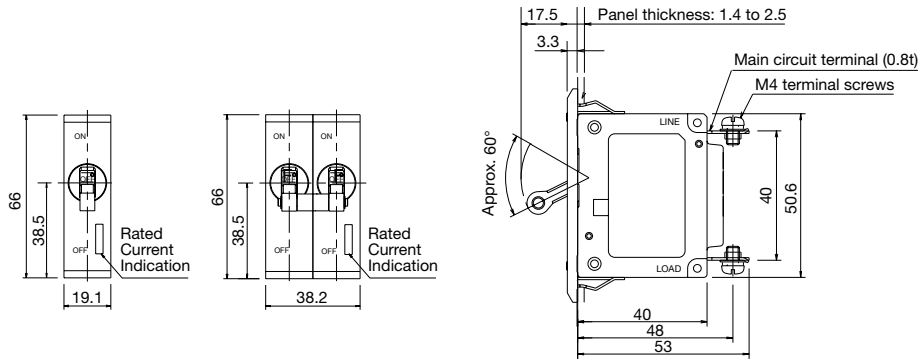

NRAN (Lever)

1-pole

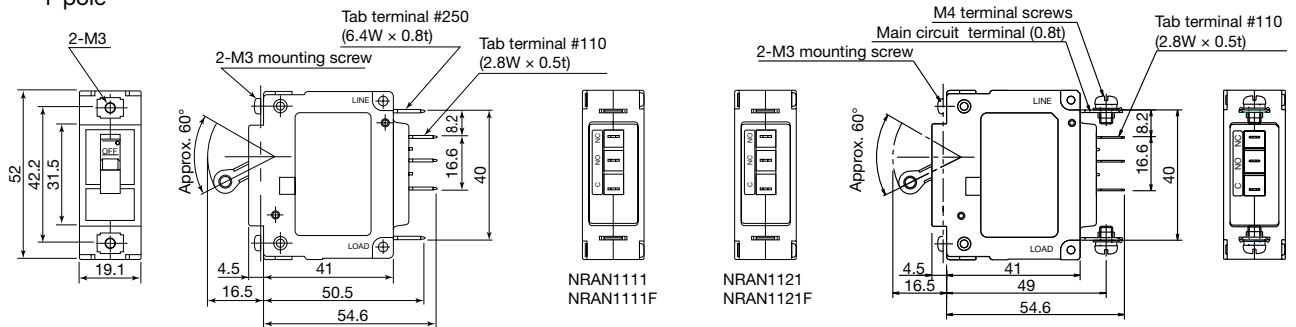

2-pole

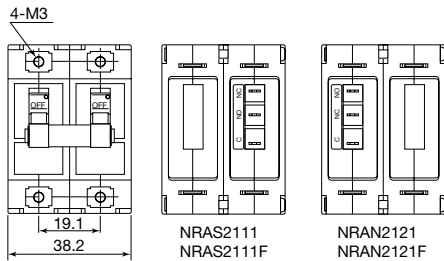

3-pole

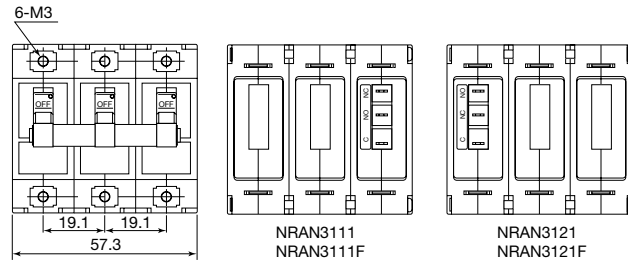

NRAR (Rocker)

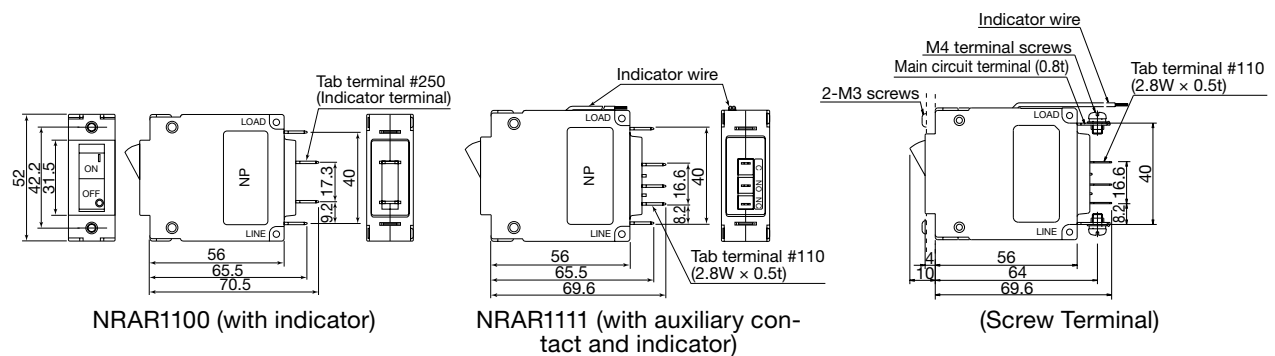

All dimensions in mm.

NRA Series Circuit Protectors

Mounting Hole Layout

Model	NRAS	NRAS with Flush Plate	NRAN and NRAR
Panel Cut-out	<p>Note: See "Accessories" for the mounting hole when the plug-in base is used.</p>	<p>Note: Flush plate is installed on the circuit protector before shipment and cannot be removed.</p>	<p>Note: "Accessories" for the mounting holes when the flush plate or plug-in base is used.</p>

- M3 screw mounting
- Tightening torque: 0.5 to 0.8 N·m

Panel Mounting Screw Length

Select the screw length with reference to the following table.

Panel thickness (mm)	0.8	1.0	1.2	1.4	1.6	1.8	2.0	2.3	2.6	3.2
Without washer	(4)	(4)	5	5	5	5	5	6	6	6
With plain washer (0.5 mm thick)	5	5	5	5	6	6	6	6	6	(7)
With spring washer (0.7 mm thick)	5	5	5	5	6	6	6	6	6	7
With plain washer (0.5 mm thick) and spring washer (0.7 mm thick)	6	6	6	6	6	6	6	(7)	(7)	8

Note: Avoid using screws in the parenthesized lengths whenever possible.

Installation Angle

Overcurrent tripping method is hydraulic magnetic. Minimum operating current varies with installation angle because operating currents are influenced by the weight of movable iron core. With reference to the following figure, correct the minimum operating current.

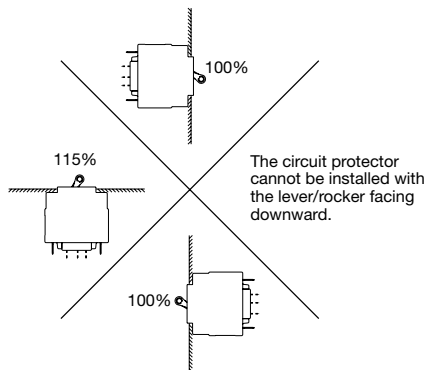

Instructions

One-pole type circuit protectors cannot be combined to make 2- or 3-pole units due to their characteristics. Order multi-pole types from IDEC.

Recommended Soldering Conditions

Solder the main terminal at a temperature of 390°C within 10 seconds using a 60W soldering iron.

Solder the auxiliary/alarm terminal at a temperature of 350°C within 3 seconds using a 60W soldering iron. (Sn-Ag-Cu lead-free solder is recommended.)

When soldering, do not touch the circuit protector housing, auxiliary and alarm contacts with the soldering iron, and do not bend the terminals or pull the wires.

Check your actual soldering conditions before soldering.

Main Circuit Terminal: Screw terminal



Applicable wire size	1.25 to 5.5 mm ²
Applicable crimping terminal	R1.25-4 to R5.5-4
No. of crimping terminal	1
Tightening torque	1.0 to 1.2 N·m

Thrust force (screw pressing load) in screw tightening should be 29N or less. The screw driver may slip out depending on the shape and conditions. In this case, hold the terminal with a tool and tighten the screw by applying a thrust force of about 50N without deforming the terminal.

NRA Series Circuit Protectors

Accessories

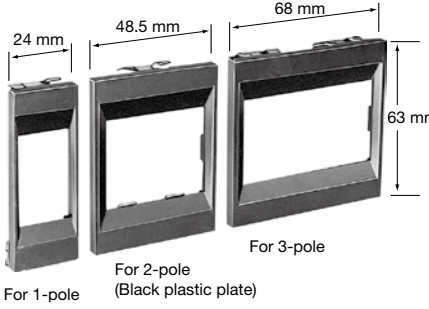
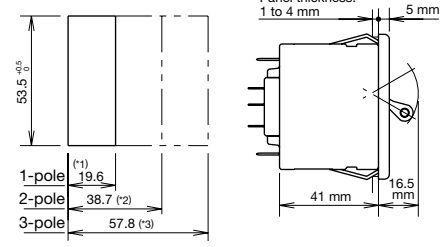
Package Quantity: 1

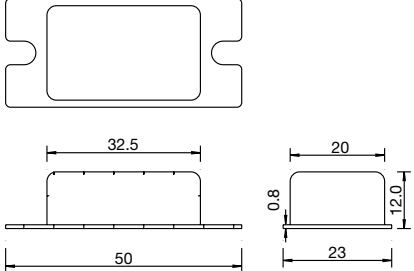
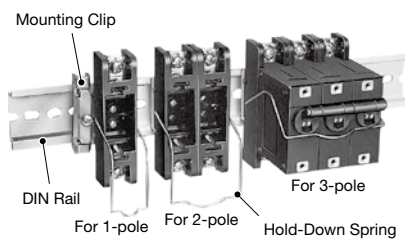
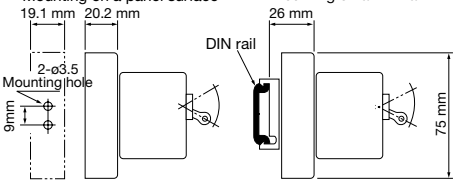
Shape	Specifications	Part No.	For Use on	Description / Dimensions	
Flush Plate  <p>For 1-pole For 2-pole (Black plastic plate) For 3-pole</p>	For 1-pole	NR31	NRAN NRAR	Mounting Hole Layout 	
	For 2-pole	NR32	NRAN		
	For 3-pole	NR33			
Dustproof Cover  (Silicon rubber)	For 1-pole	NRA-C1	NRAR		
Plug-in Base (250V AC/DC · 20A max.) 	Surface Mount	For 1-pole	NUS1	NRAS NRAN	Surface mount can mount directly on a panel surface with two M3 screws. DIN rail mount can snap onto a DIN rail. <ul style="list-style-type: none"> Applicable only for series trip units. (Not applicable for units with auxiliary and alarm contact or with indicator.) Terminal screw M4, 20A max., with hold-down spring
		For 2-pole	NUS2		
		For 3-pole	NUS3		
	DIN Rail Mount	For 1-pole	NR21	NRAS NRAN	Tightening torque: 1.0 to 1.3 N·m Mounting on a panel surface: 19.1 mm, 20.2 mm Mounting on a DIN rail: 26 mm 
		For 2-pole	NR22		
		For 3-pole	NR23		
		For 1-pole	NR211	NRAR	







Shape	Color	Part No.	Ordering No.	Package Quantity	For Use on	Description
Color Cap 	Blue	NR5S	NR5SPN05	5	NRAS	Color caps fit onto NRAS circuit protectors for color-coding circuits and improved appearance of the panel. Available in four colors: Blue (7.5B4/8 approx.) Red (7.5R5/14 approx.) White (N9.5 approx.) Yellow (2.5Y9/4 approx.)
	Red	NR5R	NR5RPN05			
	White	NR5H	NR5HPN05			
	Yellow	NR5Y	NR5YPN05			

NRL Series Circuit Protectors

Miniature circuit protectors with hydraulic-magnetic tripping system, allow for space and cost savings. Long life also reduces maintenance costs.





- Compact size (only 36.6H × 16.8W × 42D mm)
- One-lever (one-rocker) for 2-poles, ensures proper interruption to both poles when one pole is tripped.
- Low, middle, and high speed response
- Variety of rated currents and internal circuits
- Available with auxiliary contacts and inertia delay
- Over 20,000 mechanical operations
- Hydraulic-magnetic tripping system
- Safe trip-free mechanism
- Vibration-proof design

This product is recognized by Underwriters Laboratories under UL1077 as a "Supplementary Protector."

Applicable Standards	Mark	Certification Organization / File No.
UL1077		UL/c-UL recognized File No. E68029
CSA C22.2 No. 235		CSA file No. LR83454
EN60934 (VDE0642)		VDE No. 102746
EN60934		EU Low Voltage Directive (Note)
GB17701		CCC No. 2005010307151789
Electrical Appliance and Material Safety Law Technical Standard	 (For switch type)	(Electrical appliance excepting specified appliances)

For details, see the list of standard certified products in the back of this catalog.
Note: Series trip only

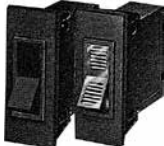
Specifications

Model	NRLT	NRLP	NRLY	NRLR	NRLK
Shape					
Operator Style	Lever (lever color: black)	Lever (lever color: black)	Rocker (non-illuminated), Illuminated rocker		Large rocker
Protection Method	Hydraulic-magnetic tripping system				
Internal Circuit	Series trip (Current trip), Relay trip (Voltage trip)* Series trip (Current trip) with auxiliary contacts, Switch only, Switch only with auxiliary contact				*: Not available on NRLP
No. of Poles	1-pole, 2-pole (1-lever)	1-pole	1-pole, 2-pole (1-rocker)		
Rated Voltage	250V AC 50/60Hz, 50V DC				
Minimum Applicable Load	24V AC/DC, 100 mA (reference value)				
Rated Current	Current trip: 0.1A, 0.5A, 1A, 2A, 3A, 4A, 5A, 7.5A, 10A, 12.5A, 15A, 20A				Switch only: 20A max.
Trip Voltage (Voltage trip)	100V AC 50/60Hz, 24V DC (operating at 90% of the rated voltage or higher, at 25°C) Voltage application duration: 1 sec maximum Trip time: 0.05 sec maximum (at the rated voltage)				
Rated Interrupting Current	250V AC 50/60Hz, 750A PC1 (UL rating: 1000A) 50V DC, 500A PC1 (UL rating: 1000A)				
Auxiliary Contact	SPDT microswitch 125V AC · 3A (resistive load), 30V DC · 2A (resistive load)				
Reference Temperature	+25°C				
Operating Temperature	-40 to +60°C (no freezing)				
Storage Temperature	-40 to +85°C (no freezing)				
Operating Humidity	45 to 85% RH (no condensation)				
Storage Humidity	45 to 85% RH (no condensation)				
Insulation Resistance	100 MΩ minimum (500V DC megger)				
Dielectric Strength	2000V AC, 1 minute (between live part and ground, between terminals of different poles, between terminals of the same pole when main contacts are open, between main circuit and auxiliary contact)				
Vibration Resistance	100 m/s ² (10 to 55 Hz), with the rated current applied				
Shock Resistance	500 m/s ² (operating extremes and damage limits), with the rated current applied (auxiliary contact: 360 m/s ²)				
Life	Electrical: Over 10,000 operations minimum (6 operations/min) Mechanical: Over 20,000 operations minimum (6 operations/min)				
Terminal Style (Note)	Main terminal: Tab terminal #250 [NRLP: PCB terminal] Auxiliary contact terminal: Solder terminal [NRLP: PCB terminal] Indicator terminal [Illuminated rocker] : Tab terminal #110				
Mounting Style	Ring mounting	PC board mounting	Snap-on mounting	Screw mounting	Screw mounting
Weight (Approx.)	1-pole: 30g, 2-pole: 60g (NRLT series trip)				

- Do not use the NRL circuit protectors in environments where they are exposed to extreme temperature, humidity, dust, corrosive gases, vibration, shock, or in a circuit where inrush current may be present, otherwise unnecessary operations and damage may occur.
 - The ratings of switch only type are 250V AC/50V DC and 20A, without protection function.
- Note: Indicator terminal of 1-pole illuminated rocker with auxiliary contact is a lead wire.

Indicator Ratings (Illuminated Rocker)





Indicator	Voltage
Neon	100 to 125V AC
LED	6V, 12V, 24V, 48V AC/DC ±10%

Note: Both neon and LED indicators have a built-in current limiting resistors.

Standard Color

Housing	Black		
Lever (NRLT and NRLP)	Black		
Rocker and Indicator		Rocker Color	Indicator Color
(NRLY) (NRLR)	Non-illuminated	Black, red, green	-
	Neon	Transparent red	Red
	LED	Transparent red	Red
Large Rocker (NRLK)		Black, Red	

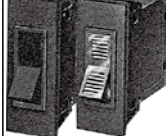
Part No. Development

[1] Model					[8] Rocker Color (Non-illuminated rocker only)		
Lever NRLT	Lever NRLP	Rocker NRLY	Rocker NRLR	Large Rocker NRLK	NRLY, NRLR rocker (non-illuminated) and NRLK large rocker only		
					Black	(Code) B	
					Green	G	
					Red	R	
					[8] Indicator Operating Voltage		
					NRLY and NRLR illuminated rocker only		
					Light Source	Rated Voltage	
					Neon	125V AC 50/60Hz	(Code) 1
						6V AC/DC	3
					LED	12V AC/DC	4
						24V AC/DC	5
						48V AC/DC	7

[1] Model	[2] No. of Poles	[3] Internal Circuit	[4] Auxiliary Contacts	[5] Inertia Delay	[6] Rated Current and Voltage	[7] Time Delay Curves
NRLT	1	1	11	F	3A	AD
	1-pole (Code) 1	Series Trip (Current Trip) Code 1	Without (Code) 00	Without (Code) Blank	• Current Trip 0.1A 5A 0.5A 7.5A 1A 10A 2A 12.5A 3A 15A 4A 20A	AC AA BA *EA AD BD *ED
	2-pole 2 NRLP is available only in 1-pole.	Relay Trip* (Voltage Trip) Code 5	w/auxiliary contacts Solder Terminal 11 PCB Terminal 14	With* F *Inertia delay is not available on curves EA and ED.	Rated Voltage 100V AC 24V DC	DC AD BD *ED *Inertia delay is not available on curves EA and ED.
		Switch Only Code 0 *NRLP is available only in series trip and switch only.				*Switch only does not require designation.

On the 2-pole type, one auxiliary contact is provided on the left side as viewed from the front.

NRLT (Lever)

Specify a rated current or voltage, and time delay curve in place of [6] [7].

Package Quantity: 1

Internal Circuit	No. of Poles	Inertia Delay	Auxiliary Contact	Part No.	Designation Code	
					[6] Rated Current or Voltage	[7] Time Delay Curve
Series Trip Current Trip	1	Without	Without	NRLT1100- [6] [7]	0.1A, 0.5A, 1A, 2A, 3A, 4A, 5A, 7.5A, 10A, 12.5A, 15A, 20A	AA, AD, BA, BD, EA, ED
			With	NRLT1111- [6] [7]		
		With	Without	NRLT1100F- [6] [7]		
			With	NRLT1111F- [6] [7]		
	2	Without	Without	NRLT2100- [6] [7]		AA, AD, BA, BD, EA, ED
			With	NRLT2111- [6] [7]		
With	Without	NRLT2100F- [6] [7]				
	With	NRLT2111F- [6] [7]				
Relay Trip Voltage Trip	1	Without	Without	NRLT1500- [6]	100V AC 24V DC	-
	2		Without	NRLT2500- [6]		
Switch Only	1	Without	Without	NRLT1000	-	-
			With	NRLT1011		
	2		Without	NRLT2000		
			With	NRLT2011		

NRL Series Circuit Protectors

NRLY (Rocker)

[Snap-on Mounting Part]

Specify a rated current or voltage, time delay curve, and indicator or rocker color in place of [6] [7] [8]. Package Quantity: 1

Illumination	Internal Circuit	No. of Poles	Inertia Delay	Auxiliary Contact	Part No.	Designation Code			
						[6] Rated Current and Voltage	[7] Time Delay Curve	[8] Indicator	[9] Rocker Color
Illuminated	Series Trip Current Trip	1	Without	Without	NRLY1100- [6] [7] - [8]	0.1A 0.5A 1A 2A 3A 4A 5A 7.5A 10A 12.5A 15A 20A	AA, AD, BA, BD, EA, ED	1: Neon 125V AC 50/60Hz 3: LED 6V AC/DC 4: LED 12V AC/DC 5: LED 24V AC/DC 7: LED 48V AC/DC	-
				With	NRLY1111- [6] [7] - [8]				
			With	Without	NRLY1100F- [6] [7] - [8]				
				With	NRLY1111F- [6] [7] - [8]				
		2	Without	Without	NRLY2100- [6] [7] - [8]				
				With	NRLY2111- [6] [7] - [8]				
			With	Without	NRLY2100F- [6] [7] - [8]				
				With	NRLY2111F- [6] [7] - [8]				
	Relay Trip Voltage Trip	1	Without	Without	NRLY1500- [6] - [8]	100V AC 24V DC	-		
		2		Without	NRLY2500- [6] - [8]				
	Switch Only	1	Without	Without	NRLY1000- [8]	-	-		
				With	NRLY1011- [8]				
		2		Without	NRLY2000- [8]				
				With	NRLY2011- [8]				
Non-illuminated	Series Trip Current Trip	1	Without	Without	NRLY1100- [6] [7] - [8]	0.1A 0.5A 1A 2A 3A 4A 5A 7.5A 10A 12.5A 15A 20A	AA, AD, BA, BD, EA, ED	-	
				With	NRLY1111- [6] [7] - [8]				
			With	Without	NRLY1100F- [6] [7] - [8]				
				With	NRLY1111F- [6] [7] - [8]				
		2	Without	Without	NRLY2100- [6] [7] - [8]				
				With	NRLY2111- [6] [7] - [8]				
			With	Without	NRLY2100F- [6] [7] - [8]				
				With	NRLY2111F- [6] [7] - [8]				
	Relay Trip Voltage Trip	1	Without	Without	NRLY1500- [6] - [8]	100V AC 24V DC	-		
		2		Without	NRLY2500- [6] - [8]				
	Switch Only	1	Without	Without	NRLY1000- [8]	-	-		
				With	NRLY1011- [8]				
		2		Without	NRLY2000- [8]				
				With	NRLY2011- [8]				

NRL Series Circuit Protectors

NRLR (Rocker)

[Screw Mounting]

Specify a rated current or voltage, time delay curve, and indicator or rocker color in place of [6] [7] [8]. Package Quantity: 1

Illumination	Internal Circuit	No. of Poles	Inertia Delay	Auxiliary Contact	Part No.	Designation Code			
						[6] Rated Current and Voltage	[7] Time Delay Curve	[8] Indicator	[9] Rocker Color
Illuminated	Series Trip Current Trip	1	Without	Without	NRLR1100-[6] [7] - [8]	0.1A 0.5A 1A 2A 3A 4A 5A 7.5A 10A 12.5A 15A 20A	AA, AD, BA, BD, EA, ED	1: Neon 125V AC 50/60Hz 3: LED 6V AC/DC 4: LED 12V AC/DC 5: LED 24V AC/DC 7: LED 48V AC/DC	-
				With	NRLR1111-[6] [7] - [8]				
			With	Without	NRLR1100F-[6] [7] - [8]				
				With	NRLR1111F-[6] [7] - [8]				
		2	Without	Without	NRLR2100-[6] [7] - [8]				
				With	NRLR2111-[6] [7] - [8]				
			With	Without	NRLR2100F-[6] [7] - [8]				
				With	NRLR2111F-[6] [7] - [8]				
	Relay Trip Voltage Trip	1	Without	Without	NRLR1500-[6] - [8]	100V AC 24V DC	-		
		2		Without	NRLR2500-[6] - [8]				
	Switch Only	1	Without	Without	NRLR1000-[8]	-	-		
				With	NRLR1011-[8]				
		2		Without	NRLR2000-[8]				
				With	NRLR2011-[8]				
Non-illuminated	Series Trip Current Trip	1	Without	Without	NRLR1100-[6] [7] - [8]	0.1A 0.5A 1A 2A 3A 4A 5A 7.5A 10A 12.5A 15A 20A	AA, AD, BA, BD, EA, ED	-	B, G, R
				With	NRLR1111-[6] [7] - [8]				
			With	Without	NRLR1100F-[6] [7] - [8]				
				With	NRLR1111F-[6] [7] - [8]				
		2	Without	Without	NRLR2100-[6] [7] - [8]				
				With	NRLR2111-[6] [7] - [8]				
			With	Without	NRLR2100F-[6] [7] - [8]				
				With	NRLR2111F-[6] [7] - [8]				
	Relay Trip Voltage Trip	1	Without	Without	NRLR1500-[6] - [8]	100V AC 24V DC	-		
		2		Without	NRLR2500-[6] - [8]				
	Switch Only	1	Without	Without	NRLR1000-[8]	-	-		
				With	NRLR1011-[8]				
		2		Without	NRLR2000-[8]				
				With	NRLR2011-[8]				

NRL Series Circuit Protectors

NRLK (Large Rocker) [Snap-on Mounting]

Specify a rated current or voltage, time delay curve, and rocker color in place of [6] [7] [8]. Package Quantity: 1

Internal Circuit	No. of Poles	Inertia Delay	Auxiliary Contact	Part No.	Designation Code		
					[6] Rated Current and Voltage	[7] Time Delay Curve	[8] Rocker Color
Series Trip Current Trip	1	Without	Without	NRLK1100- [6] [7] - [8]	0.1A 0.5A 1A 2A 3A 4A 5A 7.5A 10A 12.5A 15A 20A	AA, AD, BA, BD, EA, ED	B, G, R
			With	NRLK1111- [6] [7] - [8]			
		With	Without	NRLK1100F- [6] [7] - [8]			
			With	NRLK1111F- [6] [7] - [8]			
	2	Without	Without	NRLK2100- [6] [7] - [8]			
			With	NRLK2111- [6] [7] - [8]			
		With	Without	NRLK2100F- [6] [7] - [8]			
			With	NRLK2111F- [6] [7] - [8]			
Relay Trip Voltage Trip	1	Without	Without	NRLK1500- [6] - [8]	100V AC 24V DC	-	
	2		Without	NRLK2500- [6] - [8]		-	
Switch Only	1	Without	Without	NRLK1000- [8]	-	-	
			With	NRLK1011- [8]			
	2		Without	NRLK2000- [8]			
			With	NRLK2011- [8]			

NRLP (Lever) [PC Board Mounting]

Specify a rated current and time delay curve in place of [6] [7]. Package Quantity: 1

Internal Circuit	No. of Poles	Inertia Delay	Auxiliary Contact	Part No.	Designation Code	
					[6] Rated Current	[7] Time Delay Curve
Series Trip Current Trip	1	Without	Without	NRLP1100- [6] [7]	0.1A 0.5A 1A 2A 3A 4A 5A 7.5A 10A 12.5A 15A 20A	AA, AD, BA, BD, EA, ED
			With	NRLP1114- [6] [7]		
		With	Without	NRLP1100F- [6] [7]		AA, AD, BA, BD
			With	NRLP1114F- [6] [7]		
Switch Only	1	Without	Without	NRLP1000	-	-
			With	NRLP1014		

Internal Circuits

NRLT, NRLP, NRLY (Non-illuminated), NRLR (Non-illuminated), and NRLK

Series Trip (Current Trip)	Series Trip (Current Trip)	Relay Trip (Voltage Trip)	Switch Only	Switch Only With Auxiliary Contact												
NRLY (Illuminated), NRLR (Illuminated)																
Series Trip (Current Trip)	Series Trip (Current Trip)	Relay Trip (Voltage Trip)	Switch Only	Switch Only With Auxiliary Contact												
<p>Note 1: On the 2-pole type, one auxiliary contact is provided on the left side as viewed from the front. See the dimensional drawing for the terminal arrangement.</p> <p>Note 2: NRLP is available with series trip and switch type.</p> <p>• Wiring Example</p>		<p>• Lead wires are color-coded as follows (illuminated):</p> <table border="1" style="width: 100%; border-collapse: collapse;"> <thead> <tr> <th>Lead wire</th> <th>Color</th> <th>Neon Indicator</th> <th>LED Indicator</th> </tr> </thead> <tbody> <tr> <td>(Lead wire A)</td> <td>Red</td> <td>AC</td> <td>Positive</td> </tr> <tr> <td>(Lead wire B)</td> <td>Black</td> <td>AC</td> <td>Negative</td> </tr> </tbody> </table>			Lead wire	Color	Neon Indicator	LED Indicator	(Lead wire A)	Red	AC	Positive	(Lead wire B)	Black	AC	Negative
Lead wire	Color	Neon Indicator	LED Indicator													
(Lead wire A)	Red	AC	Positive													
(Lead wire B)	Black	AC	Negative													

Overcurrent - Time Delay Characteristics (sec at 25°C)

Time Delay Curves		Percent of Rated Current						
AC 50/60Hz	DC	100%	135%	150%	200%	400%	600%	800%
AA ★	AD ★	No Trip	3-70	2-40	1-15	0.1-4	0.01-2	0.007-0.8
BA ★	BD ★	No Trip	0.3-7	0.2-5	0.1-2	0.03-0.5	0.01-0.3	0.007-0.15
EA	ED	No Trip	0.015-0.5	0.01-0.25	0.009-0.1	0.006-0.03	0.005-0.02	0.004-0.02

Note: Curves marked with ★ are also available with inertia delay. (Inertia delay is not available for Curves ED and EA)

Time Delay Curves Note: Curves marked with ★ are also available with inertia delay.

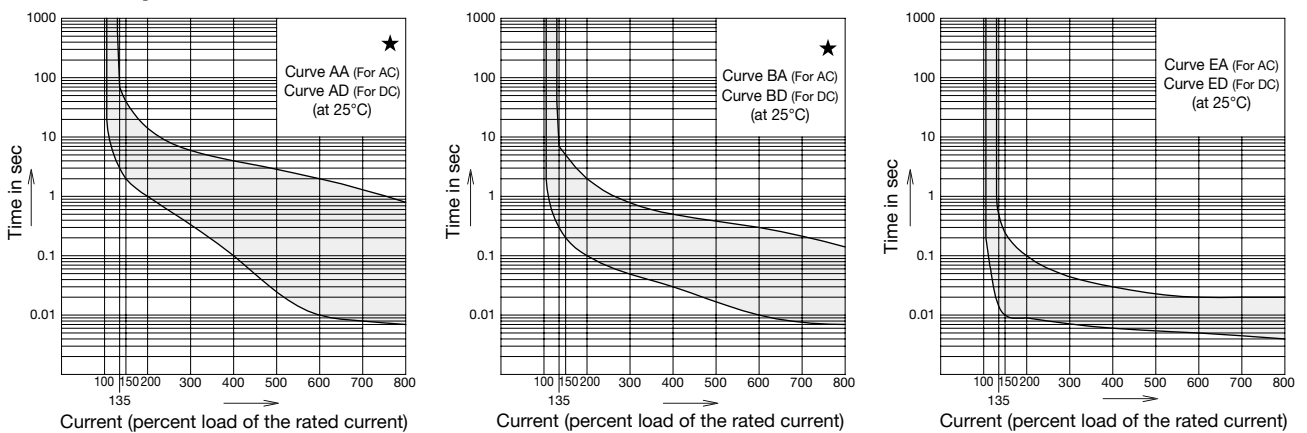

NRL Series Circuit Protectors

Circuit Protector with Inertia Delay

Inertia delay is designed not to trip on a non-repeating single pulse of 12 times the rated current (peak value) for duration of 8 ms. In addition, circuit protectors equipped with inertia delay do not respond to high inrush currents caused by transformer or lamp loads, but perform the specified interruption on the subsequent overcurrents.

Curves EA and ED are not available with inertia delay.

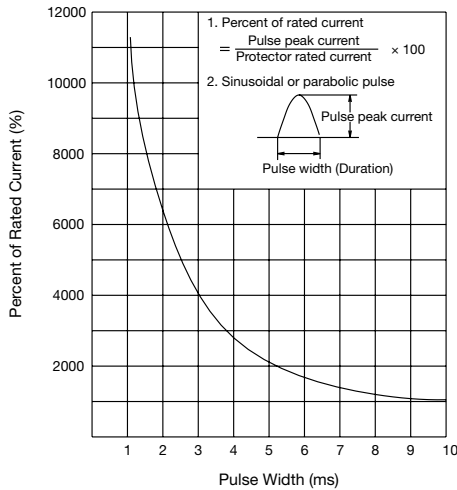

Temperature Correction Curve

The time delay curves on the preceding page are at 25°C. With reference to the following curves, time delays can be corrected according to the ambient temperature.

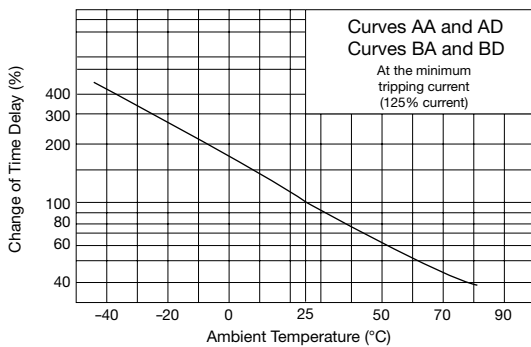

Operation of Auxiliary Contacts

At tripping or manual ON-OFF operation, there is a lag in time between the operation of the main contact and the auxiliary contact.

Rated Current (Trip Current) by Installation Angle

Overcurrent tripping method is hydraulic magnetic. Minimum operating currents vary with installation angle because operating currents are influenced by the weight of the iron core. With reference to the following figure, correct the rated current.

Note 1: The rated current does not change depending on the installation angle.

Note 2: The minimum operating current is calculated from the following formula:

$$(\text{Minimum operating current}) = (\text{Rated current}) \times 135\% \times (\text{Correction factor by installation angle})$$

Impedance and Coil Resistance (at 25°C)

[Current Trip] (initial value)

Rated Current	For AC 50/60Hz Impedance (Ω)	For DC, Impedance between Terminals (Ω)
	Curves AA, BA, and EA	Curves AD, BD, and ED
0.1A	97.0	96.0
0.5A	3.2	3.1
1A	0.81	0.78
2A	0.19	0.18
3A	0.086	0.085
4A	0.051	0.050
5A	0.034	0.034
7.5A	0.017	0.016
10A	0.0092	0.0087
12.5A	0.0068	0.0065
15A	0.0052	0.0050
20A	0.0033	0.0031

Note: Tolerance: ±25% (up to 5A), ±50% (7.5A or higher)

[Voltage trip] (initial value)

	For AC 50/60Hz Impedance (Ω)	For DC, Impedance between Terminals (Ω)
100V AC	3000	—
24V DC	—	370

Note: Tolerance: ±25%

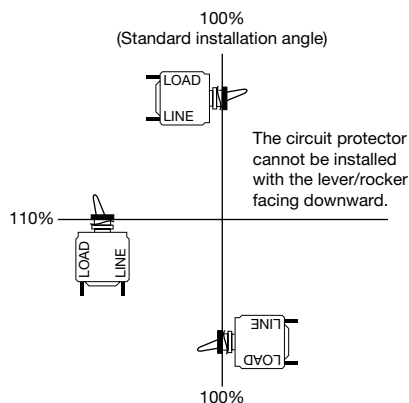
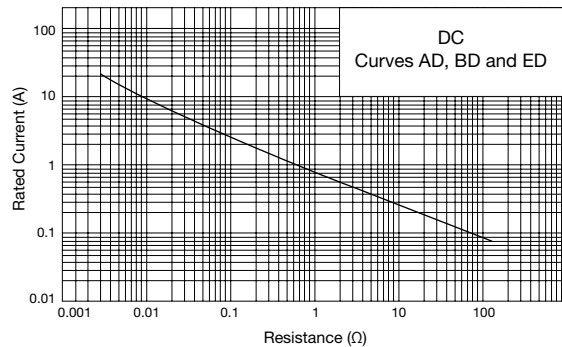
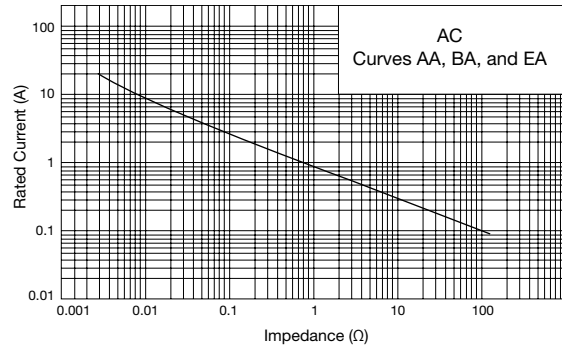

Dimensions

NRLT (Lever) Note: The dashed lines show the 2-pole type.

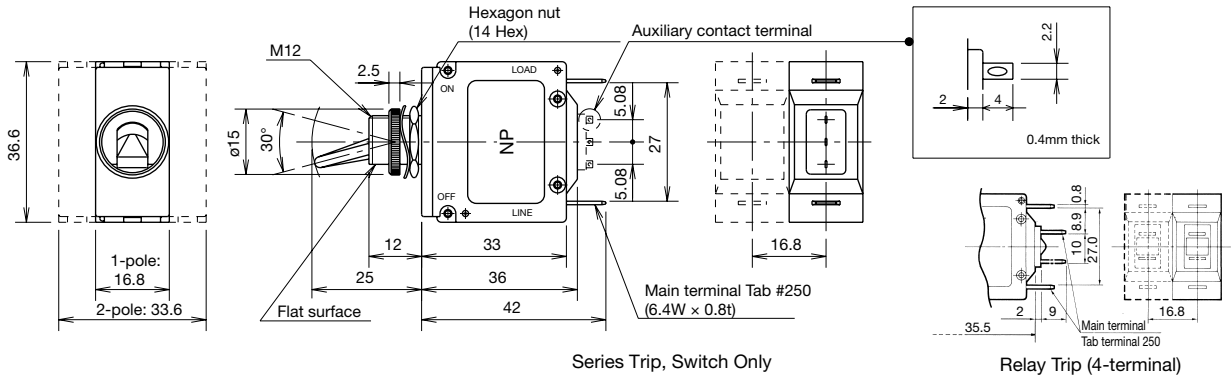

NRLP (Lever with PCB terminals)

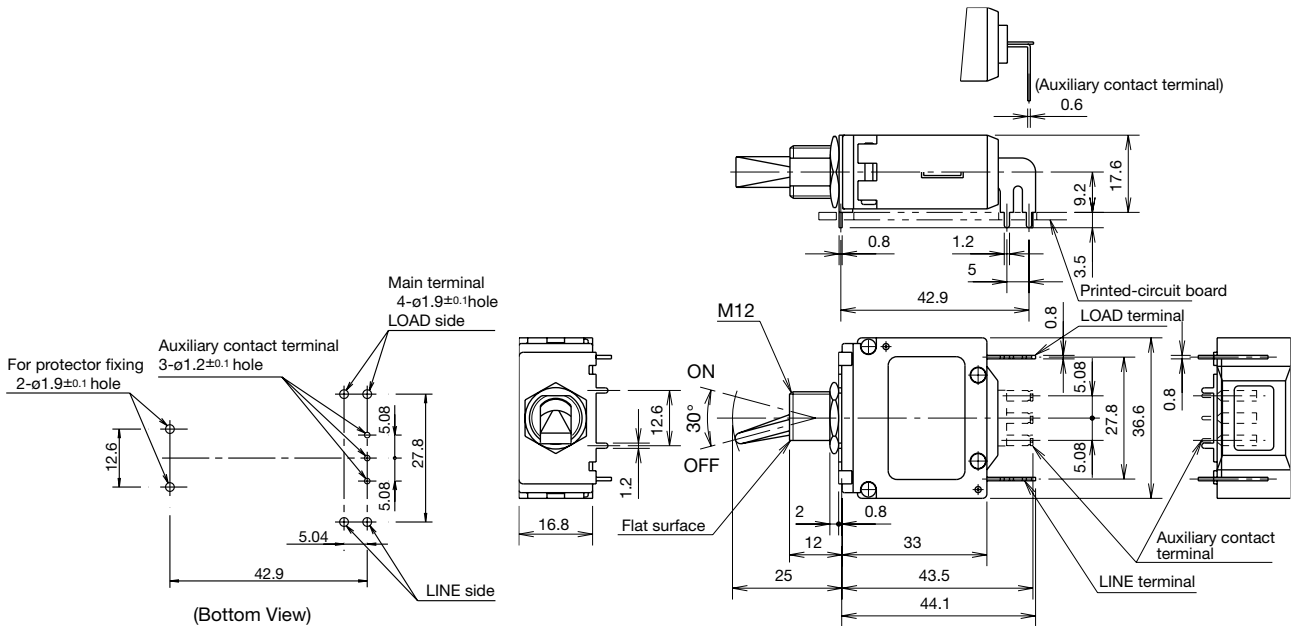

NRL Series Circuit Protectors

NRLY (Snap-on Mounting, Rocker) Note: The dashed lines show the 2-pole type.

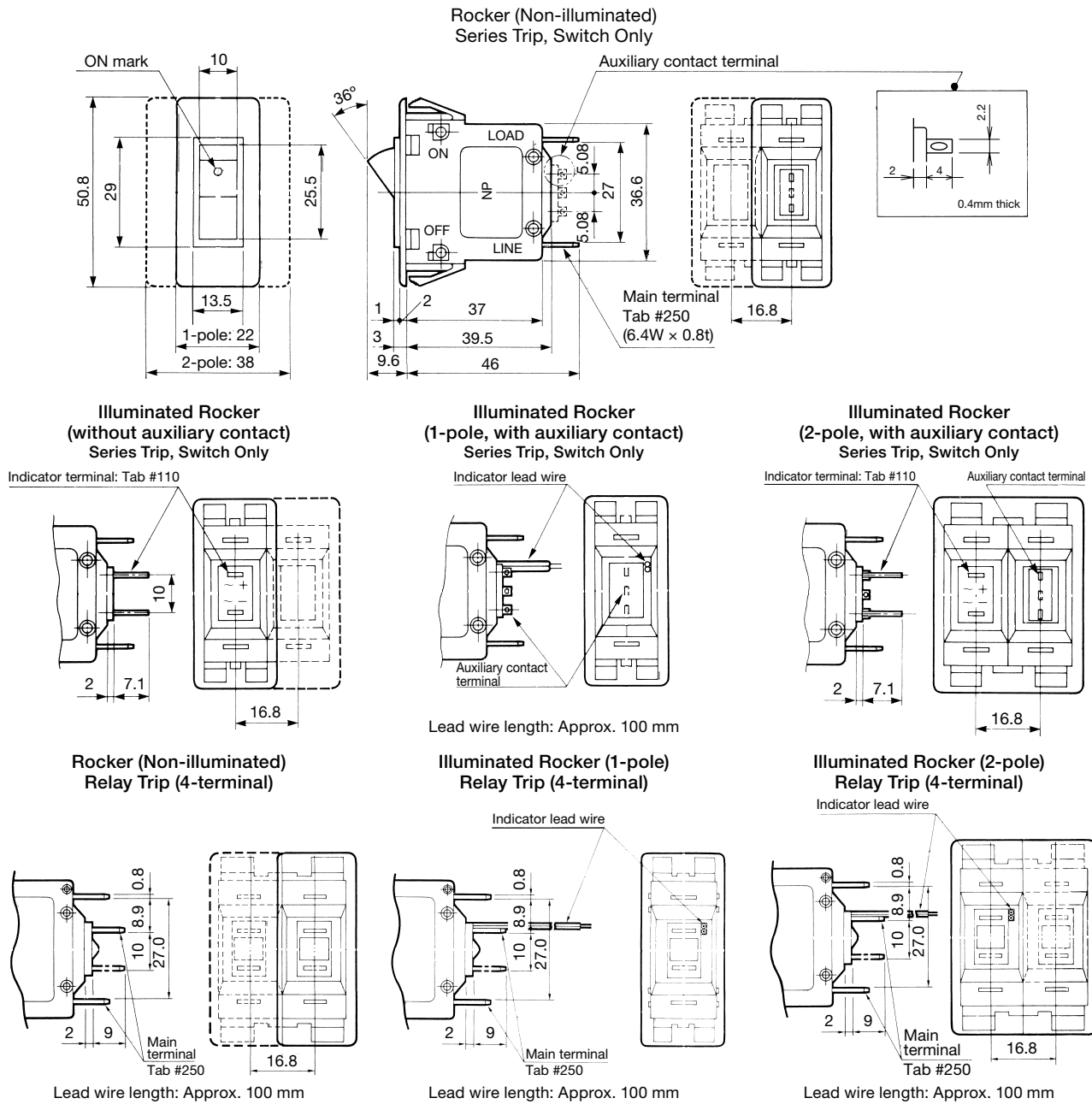

NRLK (Large Rocker) Note: The dashed lines show the 2-pole type.

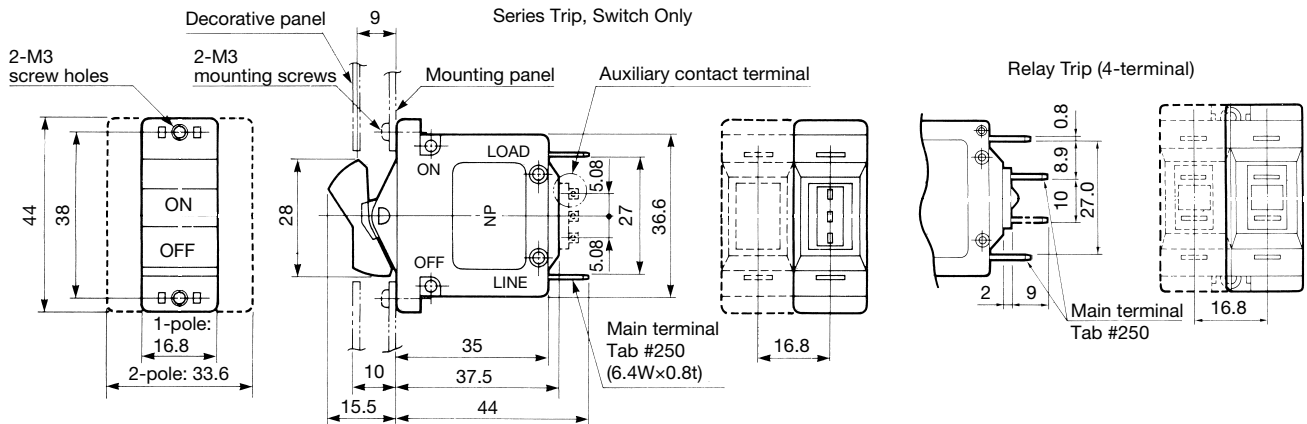

NRL Series Circuit Protectors

NRLR (Screw Mounting, Rocker) Note: The dashed lines show the 2-pole type.

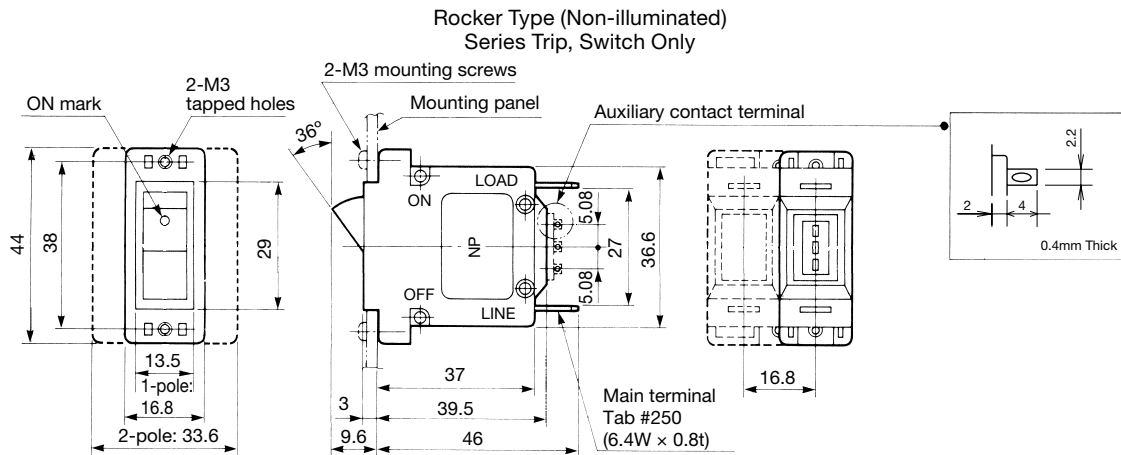

**Illuminated Rocker
(without auxiliary contact)
Series Trip, Switch Only**

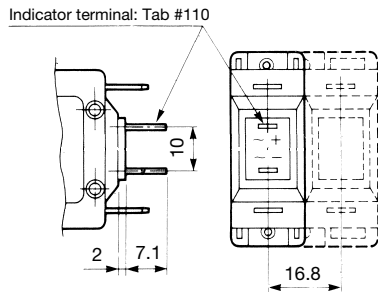

**Illuminated Rocker
(1-pole, with auxiliary contact)
Series Trip, Switch Only**

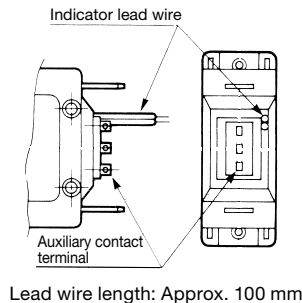

**Illuminated Rocker
(2-pole, with auxiliary contact)
Series Trip, Switch Only**

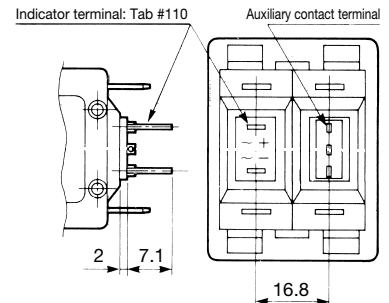

**Rocker (Non-illuminated)
Relay Trip (4-terminal)**

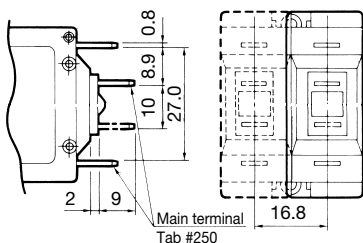

**Illuminated Rocker (1-pole)
Relay Trip (4-terminal)**

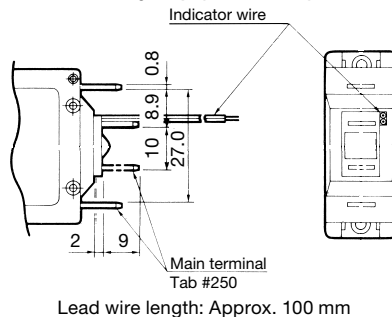

**Illuminated Rocker (2-pole)
Relay Trip (4-terminal)**

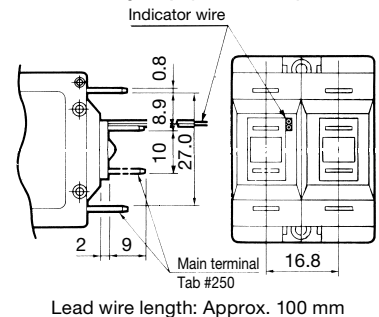

Instructions

One-pole circuit protectors cannot be combined to make 2- or 3-pole units due to their characteristics. Order multi-poles from IDEC.

Recommended Soldering Conditions

Solder the main terminal at a temperature of 390°C within 10 seconds using a 60W soldering iron.

Solder the auxiliary/alarm terminal at a temperature of 350°C within 3 seconds using a 60W soldering iron. (Sn-Ag-Cu lead-free solder is recommended.)

When soldering, do not touch the circuit protector housing, auxiliary and alarm contacts with the soldering iron, and do not bend the terminals or pull the wires.

Check your actual soldering conditions before soldering.







NRL Series Circuit Protectors

Mounting Hole Layout

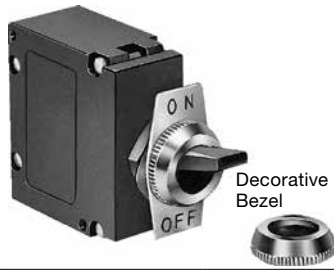
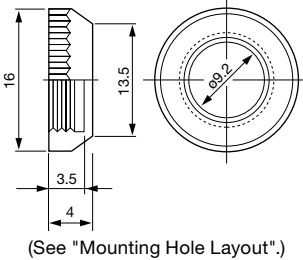
Model	NRLT (Lever)	NRLY (Snap-on Mounting, Rocker)																																																							
Panel Cut-out	<p>When anti-rotation ring is used. (Part No.: NRL-L)</p> <p>Tightening torque: 1.2 to 1.4 N·m</p>	<p>1-pole 2-pole</p>																																																							
Panel Thickness	<p>Maximum mounting panel thickness (NRLT):</p> <table border="1"> <thead> <tr> <th rowspan="2">Mounting Nut</th> <th rowspan="2">Name Plate</th> <th rowspan="2">Anti-rotation Ring</th> <th>Maximum Panel Thickness</th> </tr> <tr> <th>NRLT</th> </tr> </thead> <tbody> <tr> <td rowspan="4">When a standard bezel is used (Thickness: 2.5 mm)</td> <td>-</td> <td>-</td> <td>5.5 mm</td> </tr> <tr> <td>X</td> <td>-</td> <td>4.7 mm</td> </tr> <tr> <td>-</td> <td>X</td> <td>4.7 mm</td> </tr> <tr> <td>X</td> <td>X</td> <td>3.9 mm</td> </tr> <tr> <td rowspan="4">When a decorative bezel is used (Thickness: 4 mm)</td> <td>-</td> <td>-</td> <td>4.0 mm</td> </tr> <tr> <td>X</td> <td>-</td> <td>3.2 mm</td> </tr> <tr> <td>-</td> <td>X</td> <td>3.2 mm</td> </tr> <tr> <td>X</td> <td>X</td> <td>2.4 mm</td> </tr> </tbody> </table> <p>Note 1: Standard mounting nut is supplied with the protector. Note 2: Decorative bezel, name plate, and anti-rotation ring are sold separately. (See "Accessories" for details.)</p>	Mounting Nut	Name Plate	Anti-rotation Ring	Maximum Panel Thickness	NRLT	When a standard bezel is used (Thickness: 2.5 mm)	-	-	5.5 mm	X	-	4.7 mm	-	X	4.7 mm	X	X	3.9 mm	When a decorative bezel is used (Thickness: 4 mm)	-	-	4.0 mm	X	-	3.2 mm	-	X	3.2 mm	X	X	2.4 mm	<p>Panel thickness and Dimension A</p> <table border="1"> <thead> <tr> <th>Panel Thickness</th> <th>0.8 to 1.2 mm</th> <th>1.6 mm</th> <th>2.3 mm</th> <th>3.2 mm</th> </tr> </thead> <tbody> <tr> <td>Dimension A</td> <td>44.6 mm</td> <td>45.1 mm</td> <td>45.9 mm</td> <td>46.9 mm</td> </tr> </tbody> </table> <p>Tolerance ±0.1 mm</p> <p>Note 1: Allowable range of mounting panel thickness: 0.8 to 3.2 mm Note 2: Within the allowable range of mounting panel, Dimension A for panel thicknesses other than those listed in the above table can be calculated from the following formula: Dimension A = 45.1 + 1.1 × (Panel thickness - 1.6)</p>	Panel Thickness	0.8 to 1.2 mm	1.6 mm	2.3 mm	3.2 mm	Dimension A	44.6 mm	45.1 mm	45.9 mm	46.9 mm														
Mounting Nut	Name Plate				Anti-rotation Ring	Maximum Panel Thickness																																																			
		NRLT																																																							
When a standard bezel is used (Thickness: 2.5 mm)	-	-	5.5 mm																																																						
	X	-	4.7 mm																																																						
	-	X	4.7 mm																																																						
	X	X	3.9 mm																																																						
When a decorative bezel is used (Thickness: 4 mm)	-	-	4.0 mm																																																						
	X	-	3.2 mm																																																						
	-	X	3.2 mm																																																						
	X	X	2.4 mm																																																						
Panel Thickness	0.8 to 1.2 mm	1.6 mm	2.3 mm	3.2 mm																																																					
Dimension A	44.6 mm	45.1 mm	45.9 mm	46.9 mm																																																					
Model	NRLR (Screw Mounting, Rocker)	NRLK (Large Rocker)																																																							
Panel Cut-out	<p>1-pole/2-pole</p>	<p>1-pole/2-pole</p> <p>Panel cut-out of decorative panel Note: These dimensions are reference values. When considering the design, check the actual unit.</p>																																																							
Panel Thickness	3 mm maximum	See the dimensional drawing and select proper thickness, considering the height of mounting screw head.																																																							
Applicable Mounting Screw Length	<p>Applicable length of panel mounting screw (M3) Select proper length according to the table.</p> <table border="1"> <thead> <tr> <th>Panel thickness (mm)</th> <th>0.8</th> <th>1.0</th> <th>1.2</th> <th>1.4</th> <th>1.6</th> <th>1.8</th> <th>2.0</th> <th>2.3</th> <th>2.6</th> <th>3.2</th> </tr> </thead> <tbody> <tr> <td>Without washer</td> <td colspan="2">6 to 10 mm</td> <td colspan="3">7 to 11 mm</td> <td colspan="2">8 to 12 mm</td> <td colspan="3"></td> </tr> <tr> <td>With plain washer (0.5 mm thick)</td> <td>6 to 10 mm</td> <td colspan="3">7 to 11 mm</td> <td colspan="2">8 to 12 mm</td> <td colspan="2">9 to 13 mm</td> <td colspan="2"></td> </tr> <tr> <td>With spring washer (0.7 mm thick)</td> <td colspan="3">7 to 11 mm</td> <td colspan="2">8 to 12 mm</td> <td colspan="2">9 to 13 mm</td> <td colspan="3"></td> </tr> <tr> <td>With plain washer (0.5 mm thick), and spring washer (0.7 mm thick)</td> <td colspan="2">7 to 11 mm</td> <td colspan="3">8 to 12 mm</td> <td colspan="2">9 to 13 mm</td> <td colspan="3"></td> </tr> </tbody> </table> <p>(Tightening torque: 0.5 to 0.8 N·m)</p> <p>Screw Mounting Part Dimensions</p>		Panel thickness (mm)	0.8	1.0	1.2	1.4	1.6	1.8	2.0	2.3	2.6	3.2	Without washer	6 to 10 mm		7 to 11 mm			8 to 12 mm					With plain washer (0.5 mm thick)	6 to 10 mm	7 to 11 mm			8 to 12 mm		9 to 13 mm				With spring washer (0.7 mm thick)	7 to 11 mm			8 to 12 mm		9 to 13 mm					With plain washer (0.5 mm thick), and spring washer (0.7 mm thick)	7 to 11 mm		8 to 12 mm			9 to 13 mm				
Panel thickness (mm)	0.8	1.0	1.2	1.4	1.6	1.8	2.0	2.3	2.6	3.2																																															
Without washer	6 to 10 mm		7 to 11 mm			8 to 12 mm																																																			
With plain washer (0.5 mm thick)	6 to 10 mm	7 to 11 mm			8 to 12 mm		9 to 13 mm																																																		
With spring washer (0.7 mm thick)	7 to 11 mm			8 to 12 mm		9 to 13 mm																																																			
With plain washer (0.5 mm thick), and spring washer (0.7 mm thick)	7 to 11 mm		8 to 12 mm			9 to 13 mm																																																			

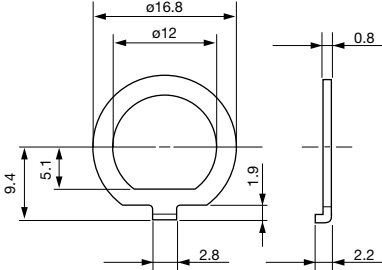
NRL series Circuit Protectors (Accessories)

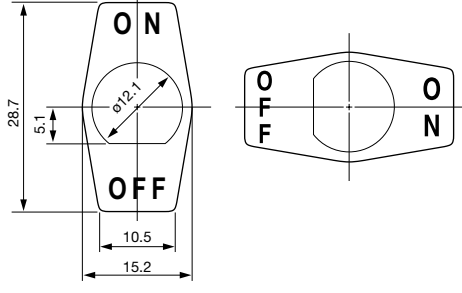
Accessories

Name and Shape		Part No.	Ordering No.	Package Quantity	Description and Dimensions
		NRL-R	NRL-RPN05	5	<ul style="list-style-type: none"> The decorative bezel can be used in place of the standard bezel. Note that the maximum panel thickness differs from that with the standard bezel. Material: Chrome-plated metal  <p>(See "Mounting Hole Layout".)</p>
		NRL-L	NRL-LPN05	5	<ul style="list-style-type: none"> The anti-rotation ring is intended to ensure firm rotation prevention. (See "Mounting Hole Layout".) Metal ring 
	(Legend)	NRL-N1	NRL-N1PN05	5	<ul style="list-style-type: none"> Aluminum plate (Aluminum colored) with black legend 
	ON OFF	NRL-N3	NRL-N3PN05		
	O F - F O N	NRL-N2	NRL-N2PN05	5	
	O - I	NRL-N4	NRL-N4PN05		

Package Quantity: 1

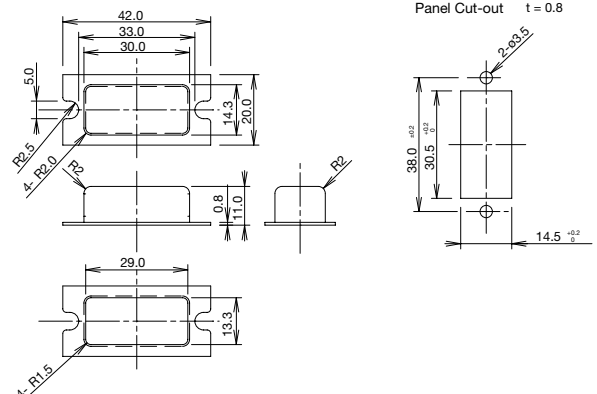
Name and Shape	Part No.	Dimensions
 <p>(Silicon Rubber)</p>	<p>For 1-pole For 2-pole</p> <p>NRL-C</p>	<ul style="list-style-type: none"> For NRLR 

NRBM Series Circuit Protectors





Variety of rated currents: 1A to 50A

Widely employed for protection of PC power circuits and large current circuits of welding machines.

NRBM is the largest in the rated current among the IDEC circuit protector series.

- Electromagnetic trip, not affected by ambient temperature
- Safe trip-free mechanism
- Available with auxiliary contact and alarm contact
- Available with inertia delay
- Vibration-proof design

This product is recognized by Underwriters Laboratories under UL1077 as a "Supplementary Protector."

Applicable Standards	Mark	Certification Organization / File No.
UL1077 CSA C22.2 No. 235		UL/c-UL recognized File No. E68029
EN60934 (VDE0642)		VDE No. 113434
EN60934		EU Low Voltage Directive
GB17701		CCC No. 2005010307151788
Electrical Appliance and Material Safety Law Technical Standard		JET



For details, see the list of standard certified products in the back of this catalog.

Specifications

Model	NRBM
Operator	Lever
Protection Method	Hydraulic-magnetic tripping system
Internal Circuit	Series trip (current trip) Series trip with auxiliary contacts Series trip with alarm contacts
No. of poles	1, 2, 3 poles
Rated Voltage	250V AC 50/60 Hz, 65V DC
Minimum Applied Load	24V AC/DC, 100 mA (reference value)
Rated Current	Current trip: 1A, 2A, 3A, 5A, 7.5A, 10A, 15A, 20A, 25A, 30A, 40A, 50A
Rated Interrupting Current	250V AC 50/60Hz, 65V DC, 1000A
Auxiliary Contact Alarm Contact	SPDT microswitch 250V AC 5A 50V DC 1A (resistive load)
Reference Temperature	+25°C
Operating Temperature	-40 to +85°C (no freezing)
Storage Temperature	-40 to +90°C (no freezing)
Operating Humidity	45 to 85% RH (no condensing)
Storage Humidity	45 to 85% RH (no condensation)
Insulation Resistance	100 MΩ minimum (500V DC megger)
Dielectric Strength	2000V AC for 1 minute (between live part and ground, between terminals of different poles, between terminals of the same poles when main contacts are open, between main circuit and auxiliary contact)
Vibration Resistance	100 m/s ² (10 to 55 Hz)
Shock Resistance	1000 m/s ²
Life	10,000 operations minimum (6 operations per minute)
Terminal Style	Main terminal: M5 stud screw Auxiliary contact and alarm contact: Tab terminal #80
Weight (Approx.)	1-pole: 100g, 2-pole: 200g, 3-pole: 300g

Note: auxiliary/alarm contact: Tab #80 terminal

- Do not use the NRBM circuit protectors in environments where they are exposed to extreme temperature, humidity, dust, corrosive gases, vibration, shock, or in a circuit where inrush current may be present, otherwise unnecessary operations and damage may occur.

Part No. Development

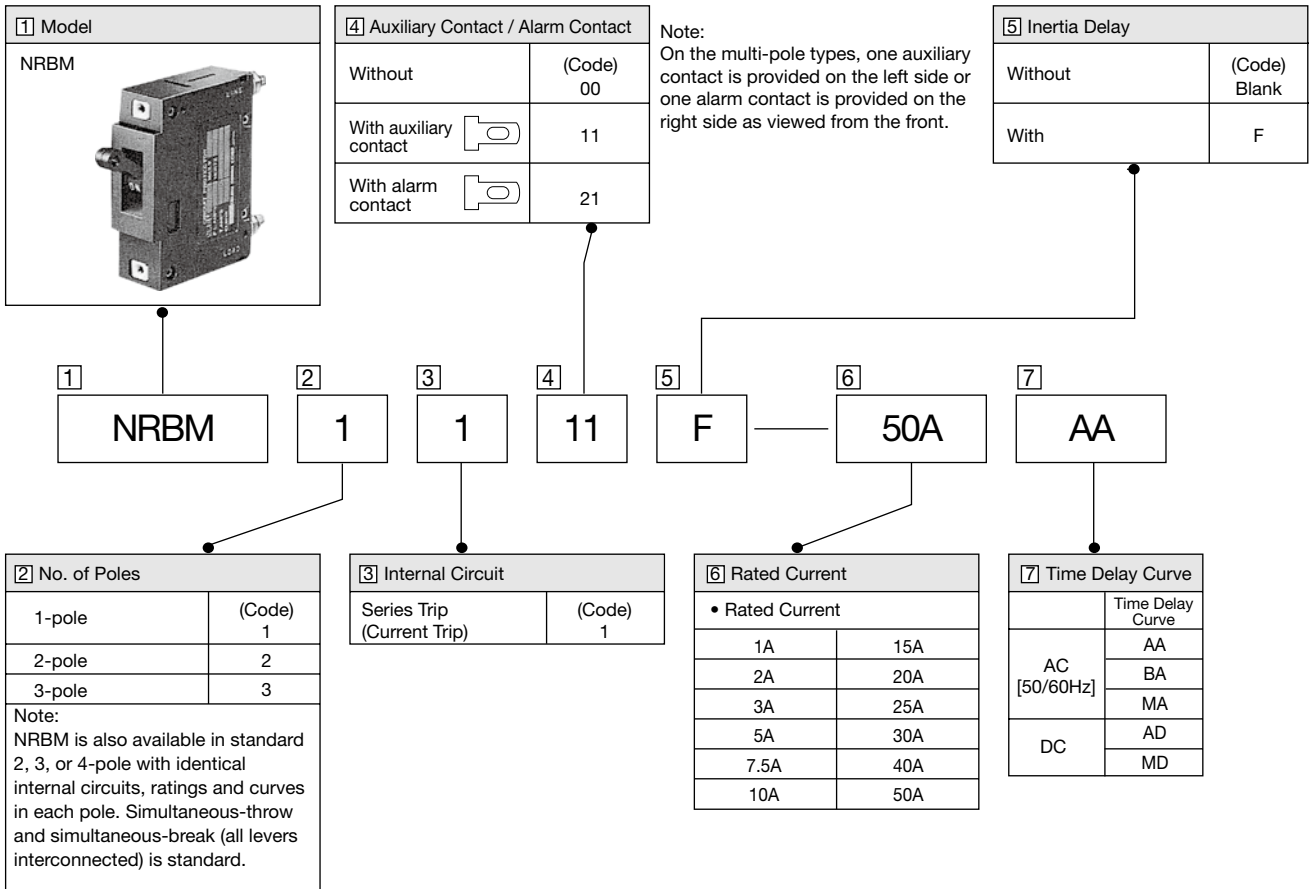

NRBM (Lever)

Specify a rated current and time delay curve in place of [6] [7].

Package Quantity: 1

Internal Circuit	No. of Poles	Inertia Delay	Auxiliary Contact Alarm Contact	Part No.	Code for Ordering	
					[6] Rated Current	[7] Time Delay Curve
Series Trip Current Trip	1	Without	Without	NRBM1100- [6] [7]	1A 2A 3A 5A 7.5A 10A 15A 20A 25A 30A 40A 50A	AA BA MA AD MD
			w/Auxiliary Contact	NRBM1111- [6] [7]		
			w/Alarm Contact	NRBM1121- [6] [7]		
		With	Without	NRBM1100F- [6] [7]		
			w/Auxiliary Contact	NRBM1111F- [6] [7]		
			w/Alarm Contact	NRBM1121F- [6] [7]		
	2	Without	Without	NRBM2100- [6] [7]		
			w/Auxiliary Contact	NRBM2111- [6] [7]		
			w/Alarm Contact	NRBM2121- [6] [7]		
		With	Without	NRBM2100F- [6] [7]		
			w/Auxiliary Contact	NRBM2111F- [6] [7]		
			w/Alarm Contact	NRBM2121F- [6] [7]		
3	Without	Without	NRBM3100- [6] [7]			
		w/Auxiliary Contact	NRBM3111- [6] [7]			
		w/Alarm Contact	NRBM3121- [6] [7]			
	With	Without	NRBM3100F- [6] [7]			
		w/Auxiliary Contact	NRBM3111F- [6] [7]			
		w/Alarm Contact	NRBM3121F- [6] [7]			

NRBM series Circuit Protectors

Internal Circuits

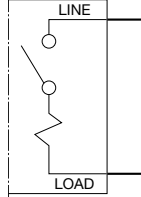
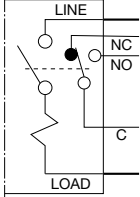
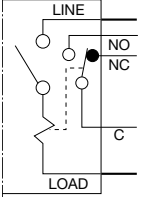
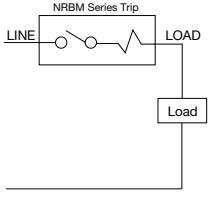
Shape	Series Trip (Current Trip)	Series Trip (Current Trip) With Auxiliary Contact	Series Trip (Current Trip) With Alarm Contact	Wiring Example
				

Overcurrent - Time Delay Characteristics (sec at 25°C)

Type	Time Delay Curve	Percent of Rated Current							
		100%	125%	150%	200%	400%	600%	800%	1000%
AC 50/60Hz	AA	No Trip	15-120	8-45	3-15	0.48-2.5	0.06-0.8	0.007-0.13	0.005-0.04
	BA	No Trip	0.75-10	0.45-3.5	0.22-1.3	0.045-0.22	0.012-0.12	0.005-0.06	0.004-0.03
	MA	No Trip	70-900	30-260	10-70	1.8-11	0.5-4	0.009-1.1	0.006-0.2
DC	AD	No Trip	10-130	6-55	2.6-20	0.5-3.5	0.14-1.4	0.008-0.7	0.005-0.35
	MD	No Trip	35-400	20-180	8-60	1.6-10	0.6-4.5	0.01-2	0.007-0.5

Note: Circuit protectors with inertia delay may have a slightly longer time delay at 600% or higher.

Time Delay Curves

For AC

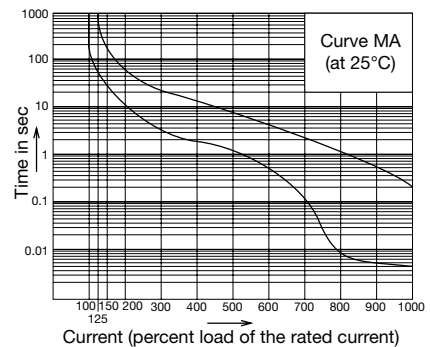
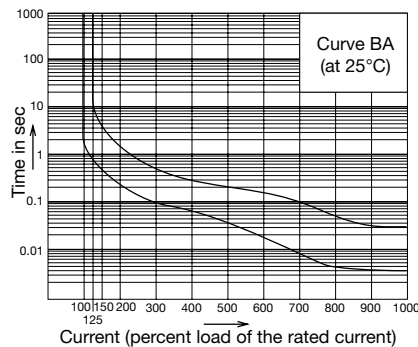
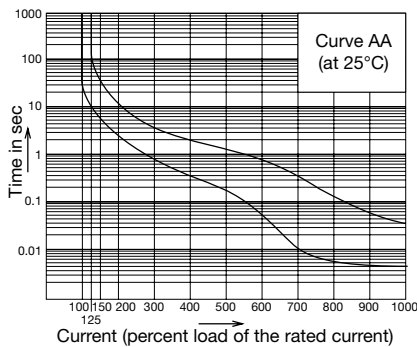

For DC

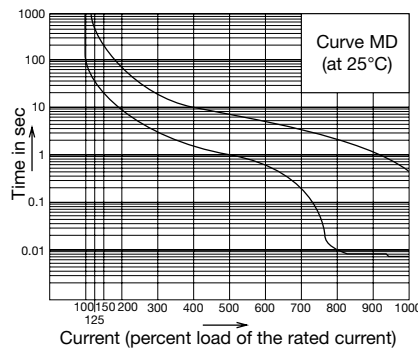
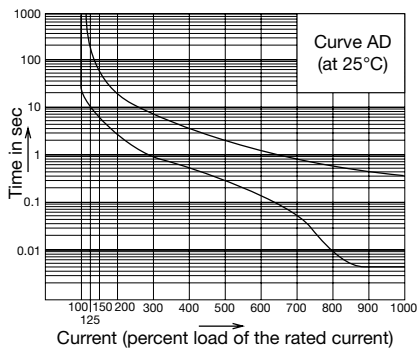

Dimensions

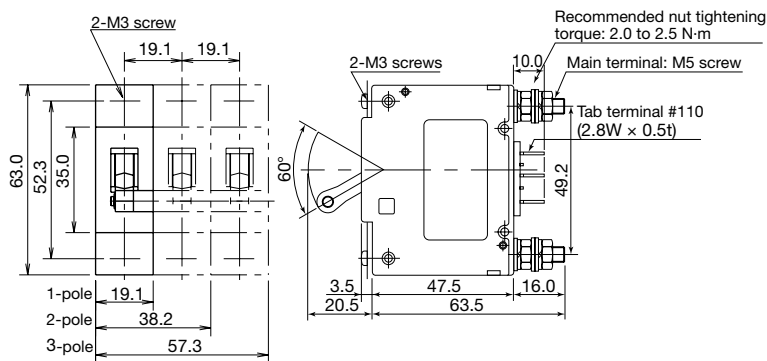

Mounting Hole Layout

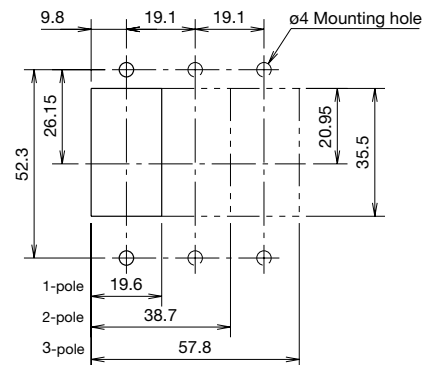

Circuit Protector with Inertia Delay

Circuit protectors equipped with inertia delay do not respond to high inrush currents caused by transformer or lamp loads, but perform the specified interruption on the subsequent overcurrents.

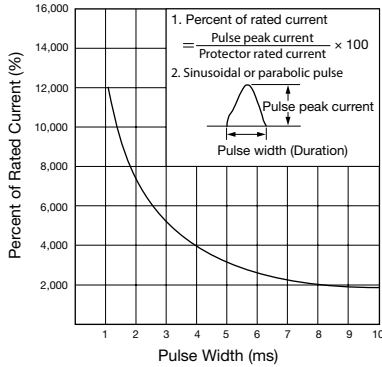

Note: Inertia delay is designed not to trip on a pulse of 20 times the rated current (peak value) for a duration of 8 ms. See the above curve.

Impedance and Coil Resistance (at 25°C) (initial value)

Rated Current (A)	For AC 50/60Hz Impedance (Ω)	For DC Resistance (Ω)
	Curves AA, BA, and MA	Curves AD and MD
1	1.1	1
2	0.245	0.227
3	0.11	0.091
5	0.039	0.035
7.5	0.018	0.015
10	0.0124	0.0088
15	0.0065	0.005
20	0.0047	0.003
25	0.0032	0.0023
30	0.0031	0.0019
40	0.002	0.001
50	0.0016	0.0006

Note: Tolerance: ±25% (up to 20A), ±50% (25A or higher)

Voltage Drop due to Coil Resistance or Impedance

The internal resistance or impedance of a circuit protector tends to be larger for a smaller rated current. Therefore, when circuit protectors of a small rated current are used for a power-supply switch, voltage drop should be taken into consideration. Internal resistance also varies with time delay curves in spite of the same rated current, which should be also considered during installation.

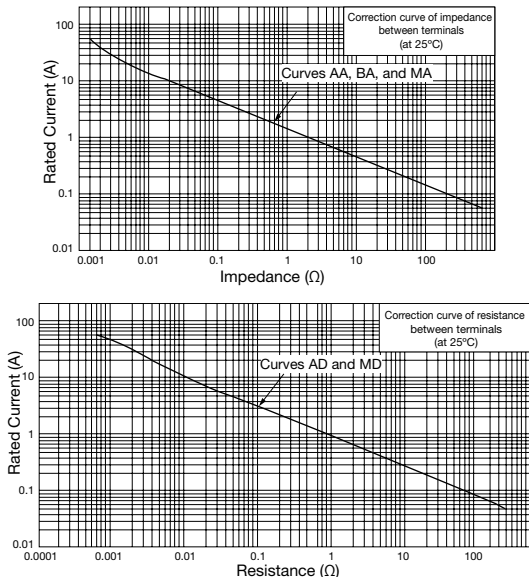

Temperature Correction Curve

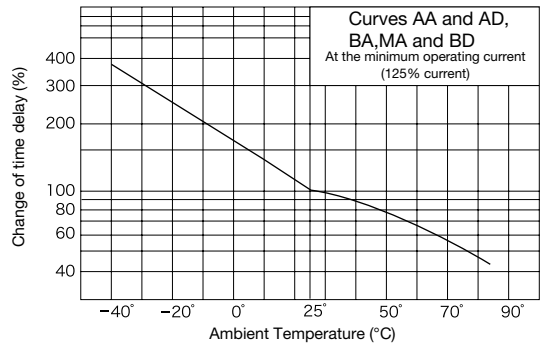

Time Delay Curve and Ambient Temperature

Since the NRBM series circuit protectors employ an electro-magnetic tripping system, the rated current (trip current) is not affected by ambient temperatures, but the time delay varies with the oil viscosity in the oil dash pot. Lower oil viscosity at higher temperatures results in shorter delay, whereas at lower temperatures the delay will be prolonged.

The time delay curves on the preceding page are at 25°C. With reference to these curves, time delays can be corrected.

Instructions

Panel Mounting Screw Length

Select a proper screw length according to the table.

Panel thickness (mm)	0.8	1.0	1.2	1.4	1.6	1.8	2.0	2.3	2.6	3.2
Without washer	(4)	(4)	5	5	5	5	5	6	6	6
With plain washer (0.5 mm thick)	5	5	5	5	6	6	6	6	6	(7)
With spring washer (0.7 mm thick)	5	5	5	5	6	6	6	6	6	7
With plain washer (0.5 mm thick) and spring washer (0.7 mm thick)	6	6	6	6	6	6	6	(7)	(7)	8

Note: Avoid using screws in the parenthesized lengths whenever possible.

M3 Screw Mounting

Tightening torque: 0.5 to 0.8 N·m minimum

Installation Angle

Designed to be mounted on a vertical surface in principle, the circuit protector must be mounted on a surface within 10° from a vertical plane. If the circuit protector is mounted on a horizontal surface or at any angle other than specified, the characteristics will be changed.

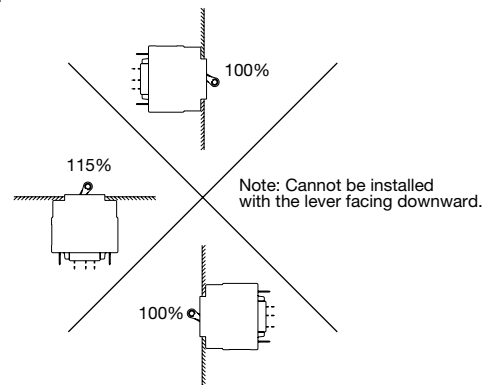

Overcurrent tripping method is hydraulic magnetic. Minimum operating currents vary with installation angle because operating currents are influenced by the weight of the iron core. With reference to the following figure, correct the rated current.

Multi-pole

Multi-pole such as 2- or 3-pole are assembled by IDEC. Because of their characteristics, 1-pole protectors cannot be combined to provide multi-pole.

NRF Series Circuit Protectors

Snaps into a 16-mm-diameter hole

Wide variety of applications such as office automation equipment

- 16-mm-dia fuse holder size
- More than 1,000 repeat operations
- Snap-on mounting
- Visible trip indicator
- Variety of rated currents
- Available with auxiliary contact which can be used to make an alarm or control circuit
- Solder or quick-connect terminations
- Round design and colorful bezels
- Mounting on 35-mm-width DIN rails is made possible by using a special adapter
- Cycling trip-free mechanism

This product is recognized by Underwriters Laboratories under UL1077 as a "Supplementary Protector."



Applicable Standards	Mark	Certification Organization / File No.
UL1077		UL recognized File No. E68029
CSA C22.2 No. 235 (Note 1)		CSA file No. LR83454
EN60934 (Note 2)		TÜV SÜD
GB17701		CCC No. 2005010309151798

For details, see the list of standard certified products in the back of this catalog.

Note 1: Only NRF series circuit protectors without manual OFF mechanism are certified by CSA.

Note 2: NRF110, rated current 8A, 10A, and 15A, without manual OFF mechanism

Specify a rated current and the bezel color code in place of [1] [2].

Package Quantity: 1

Auxiliary Contact	Internal Circuit	Manual OFF Mechanism	Part No.	Standard	Designation Code	
					[1] Rated Current	[2] Bezel Color
w/o Auxiliary Contact		Without	NRF110 [2]-[1]	UL CSA CCC	0.3A, 0.5A	
			NRF110 [2]-[1]	UL CSA CCC TÜV (Note)	1A, 2A, 3A, 5A, 8A, 10A, 15A	
		With	NRF210 [2]-[1]	UL CCC	0.3A, 0.5A	
			NRF210 [2]-[1]	UL CCC	1A, 2A, 3A, 5A, 8A, 10A, 15A	
w/Auxiliary Contact		Without	NRF111 [2]-[1]	UL CSA CCC	0.3A, 0.5A, 1A, 2A, 3A, 5A, 8A, 10A, 15A	
		With	NRF211 [2]-[1]	UL CCC		

Bezel Color	Code
Black	Blank
Green	G
Red	R
Blue	S
White	W
Yellow	Y

Note: TÜV approved models are for 8A, 10A, and 15A only. When ordering the TÜV approved models, specify "-EN" at the end of the Part No.

Part No. Development

When ordering, specify the Part No. the rated current, and the bezel color code.

[Example]

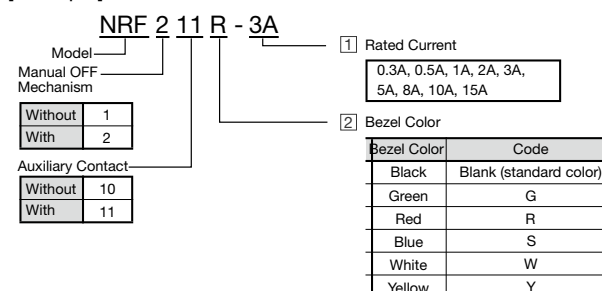

Wiring Example

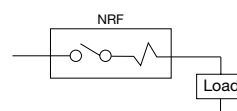

Manual OFF Mechanism

Manual OFF mechanism opens the main contacts by pressing the button, convenient for checking the circuit with power OFF. When manually turning OFF, make sure that the current is not applied (under no-load condition).

Specifications

Protection Method	Thermal tripping
Internal Circuit	Series trip Series trip (w/auxiliary contact)
No. of Poles	1 pole
Rated Voltage	250V AC, 32V DC
Rated Current	0.3A, 0.5A, 1A, 2A, 3A, 5A, 8A, 10A, 15A
Minimum Applicable Load	24V AC/DC 100mA (reference value)
Rated Interrupting Current	300 mA to 5A: Rated current × 6 8, 10, and 15A: Rated current × 10 (Turns on when the main circuit is off, including tripping.)
Auxiliary Contact Rating	1NO (contact output) 125V AC / 32V DC, 50mA
Reference Temperature	25°C
Operating Temperature	-10 to +60°C (no freezing)
Storage Temperature	-30 to +80°C (no freezing)
Operating Humidity	45 to 85% RH (no condensation) (Note 1)
Storage Humidity	45 to 85% RH (no condensation)
Trip Time (at 25 °C)	No trip at the rated current Within 1 hour at 135% the rated current
Reset Time	60 sec minimum (Note 2)
Vibration Resistance	100 m/s ² (10 to 55 Hz)
Shock Resistance	Damage limits: 1000 m/s ² , Operating extremes: 500 m/s ²
Life	Overcurrent durability: 1,000 operations minimum (tripping at 200% the rated current) Mechanical life (with manual OFF mechanism): 240 operations minimum (switching at no load)
Insulation Resistance	100 MΩ minimum (500V DC megger)
Dielectric Strength	Between main contacts and between main contact and ground: 2000V AC, 1 minute Between main and auxiliary contacts: 1500V AC, 1 minute
Terminal Style	Main terminal: Tab terminal #250 Auxiliary contact terminal: 1.4W × 0.2mm thick solder terminal
Degree of Protection	IP40 (IEC 60529)
Weight (Approx.)	15g

Note 1: The rated current is the value at the reference ambient temperature of 25°C, and varies with the operating temperature. The rated current can be corrected according to the temperature correction curve.

Note 2: Reset time is the value at the reference ambient temperature of 25°C.

Time Delay Curves

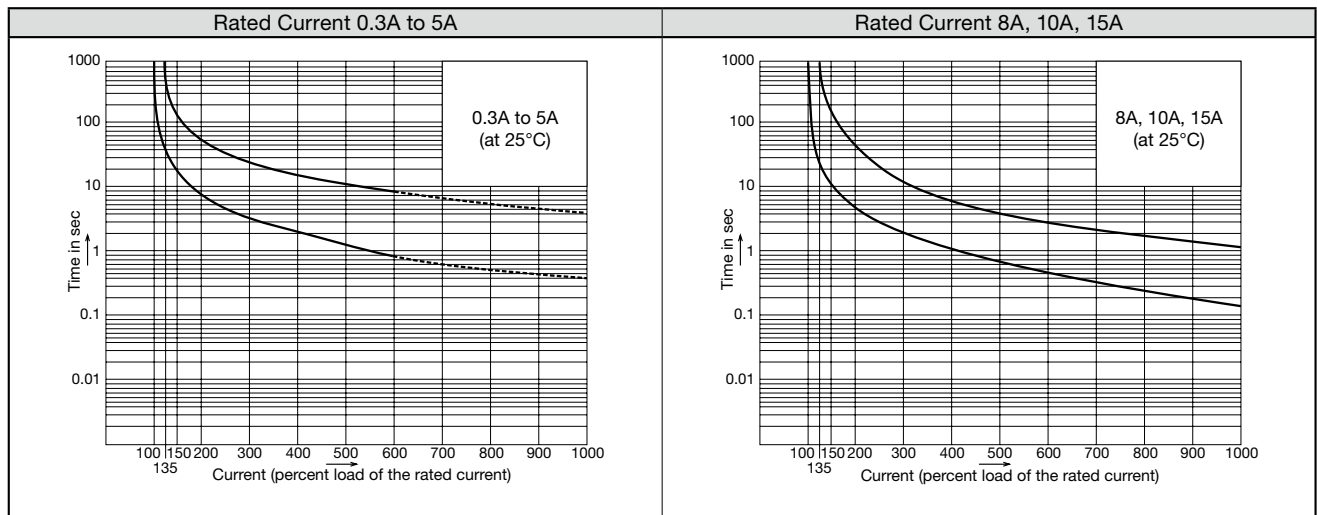

Note: Dashed lines are reference values.

Overcurrent Trip Time

0.3A to 5A

Percent of Rated Current	100%	135%	150%	200%	400%	600%
Trip Time (sec)	NO TRIP	30 to 3600	16 to 120	7 to 55	2 to 17	0.9 to 8.5

(Ambient temperature + 25°C)

8 to 15A

Percent of Rated Current	100%	135%	150%	200%	400%	600%	800%	1000%
Trip Time (sec)	NO TRIP	28 to 3600	10 to 130	5 to 50	1 to 7	0.45 to 3	0.25 to 1.8	0.15 to 1.2

(Ambient temperature + 25°C)

Applications

NRF series circuit protectors are small, high-performance over-current protectors developed for use in control circuits and small electrical equipment. Because they can be easily reset, they are suited for use in relay circuits, motor circuits, heater circuits, transformers, solenoids, solenoid valves, semiconductor circuits, and many other applications.

[Application Examples]

Office Automation Equipment

Copiers, shredders, personal computers, word processors, fax machines, printers, computer terminals, communication equipment, and power supplies.

Measuring Instruments

Electrical measuring instruments, industrial meters, analyzers, recorders, data processors, test equipment, and chemical equipment

Industrial Machines

CNC equipment, robots, molding machines, processing machines, packaging machines, and carriers

Business machines

Medical equipment, vending machines, hairdresser's equipment, recreation and game machines, and small printing machines

Electric Controller and Instrumentation Equipment

Automatic control devices, electronic equipment, and instrumentation boards

NRF Series Circuit Protectors

Rated Current vs Internal Resistance

Rated Current	Internal Resistance (Ω) $\pm 15\%$	Remarks
0.3A	9.08	at 25°C
0.5A	3.27	
1A	0.81	
2A	0.235	
3A	0.0922	
5A	0.0503	
8A	0.0085	
10A	0.0095	
15A	0.0064	

The internal resistance tends to be larger for smaller rated currents. When the circuit protector is used in a low-voltage circuit, voltage drop should be taken into consideration.

Temperature Correction Curve

The rated current is based on an ambient temperature of 25°C. Since a thermal tripping method is employed, the rated current should be corrected according to the ambient temperature with reference to the curves shown below.

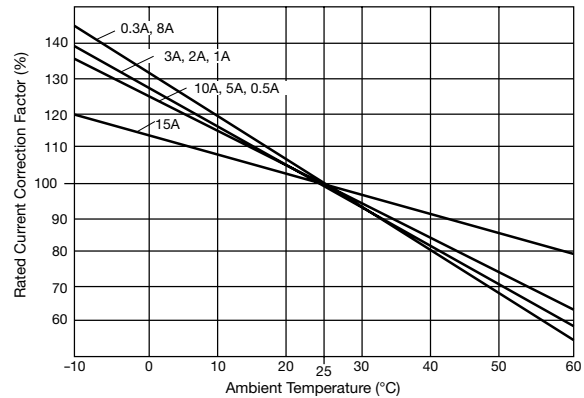

Dimensions

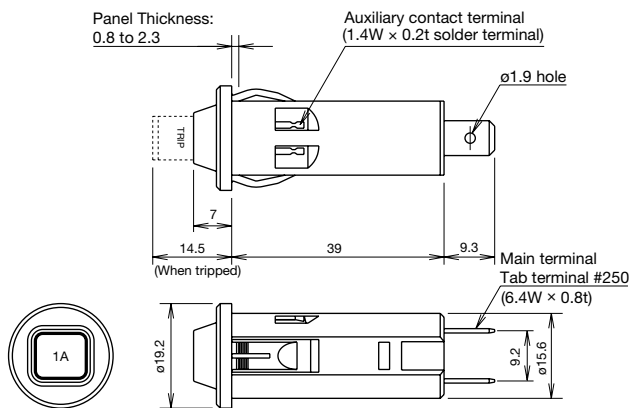

Mounting Hole

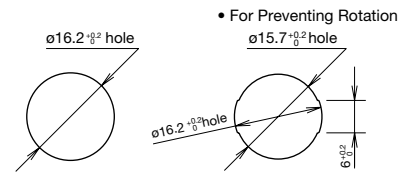

* Chamfering on the front edge of the mounting hole is recommended for easy insertion.

Accessories

35-mm-wide DIN Rail Mount Adapter

Part No.	Ordering No.	Package Quantity
NRF-D	NRF-DPN05	5

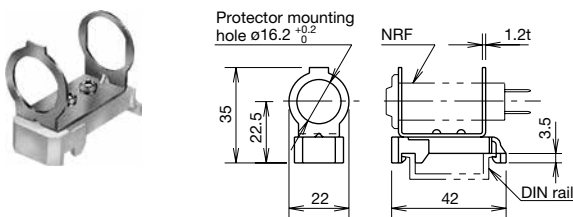

Surface Mount Adapter

Part No.	Ordering No.	Package Quantity
NRF-M	NRF-MPN10	10

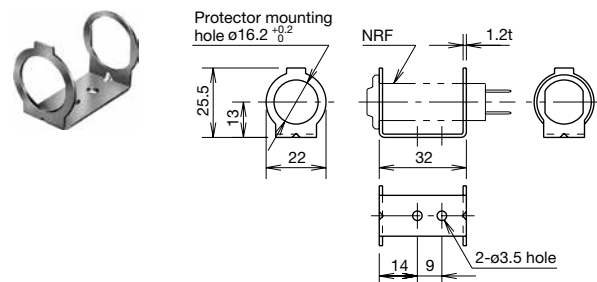

All dimension in mm.

Instructions

1. Since the NRF is designed for protection against overload, it should be used within the rated interrupting current. An excessive overcurrent may affect the bimetal characteristics or damage the internal mechanism.
2. After tripping, the NRF cannot be reset until the bimetal cools down. Allow the NRF at least 60 seconds before resetting. When the NRF is used at an ambient temperature higher than the reference temperature, resetting sometimes fails even after 60 seconds because it takes a long time to cool down the bimetal.
3. The NRF may not trip at an instantaneous overcurrent due to its principle.

4. The NRF is shipped in the ON status. To confirm operation of the models without manual OFF mechanism, apply approximately 200% the rated current to trip the NRF.
5. When installing quick connect receptacles to the terminals, hold the NRF body and press it into the quick connect receptacles.
6. Unlike conventional switches, the models with manual OFF mechanism are not suited for frequent switching due to their construction. (Their mechanical life is 240 operations at minimum when switching at no load.)
7. The models with manual OFF mechanism should be operated without load.

Recommended Soldering Conditions

Solder the main terminal at a temperature of 390°C within 10 seconds using a 60W soldering iron. Solder the auxiliary/alarm terminal at a temperature of 350°C within 3 seconds using a 60W soldering iron. (Sn-Ag-Cu lead-free solder is recommended.) When soldering, do

not touch the circuit protector housing, auxiliary and alarm contacts with the soldering iron, and do not bend the terminals or pull the wires. Check your actual soldering conditions before soldering.



NRP Series PC Board Circuit Protectors

Higher economic efficiency than a fuse

- SIL subminiature circuit protectors adopting IC terminal arrangements, and mountable directly on PC boards
- Simple construction and high performance applying a positive load reversing mechanism by IDEC's original design
- Unlike fuses, the thermal trip mode (bimetal) eliminates erroneous interruption due to inrush currents.
- Rated current can be selected to meet the load. Circuits with high inrush currents can be protected against overloads (unlike fuses).
- Reusable 200 operations (tripping at 200% the rated current) with higher economic efficiency, and less maintenance than fuses.
- Available in slim and flat styles. Slims (can be mounted on PC boards by using pick and place machines).
- Available in non-sealed and sealed types. With the sealed type, cleaning after soldering is possible.
- With a manual OFF mechanism, convenient for circuit checkups

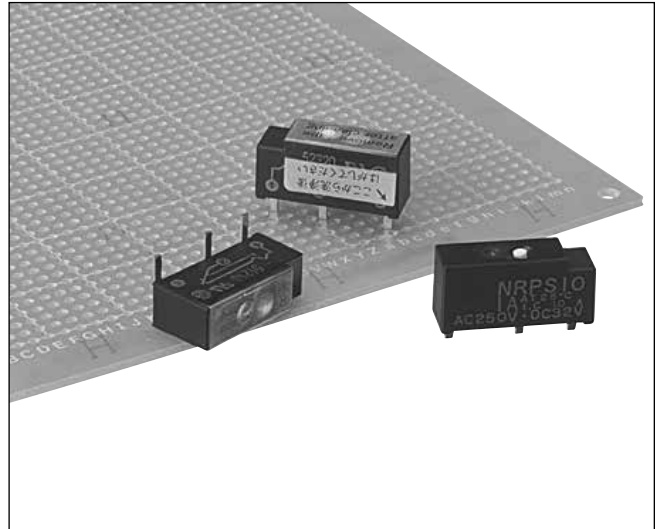
This product is recognized by Underwriters Laboratories under UL1077 as a "Supplementary Protector."



Applicable Standard	Mark	Certification Organization / File No.
UL1077		UL recognized File No. E68029
CSA C22.2 No. 235		CSA file No. LR65560

For details, see the list of standard certified products in the back of this catalog.

Specify a rated current in place of □.

Style		Shape	Part No.	Ordering No.	□ Rated Current	Contact	Internal Circuit (Note)	Package Quantity
NRPS (Slim)	Non-sealed		NRPS10-□	NRPS10-□PN10	1A, 1.6A, 2A, 3.15A, 4A, 5A, 6A	1NC		10
	Sealed (Tape-sealed)		NRPS10-G□	NRPS10-G□PN10	1A, 1.6A, 2A, 3.15A, 4A, 5A, 6A	1NC		10
NRPF (Flat)	Non-sealed		NRPF10-□	NRPF10-□PN10	1A, 1.6A, 2A, 3.15A, 4A, 5A, 6A	1NC		10
	Sealed (Tape-sealed)		NRPF10-G□	NRPF10-G□PN10	1A, 1.6A, 2A, 3.15A, 4A, 5A, 6A	1NC		10
NRPS (Slim)	Non-sealed		NRPS11-□	NRPS11-□PN10	1A, 1.6A, 2A, 3.15A, 4A, 5A, 6A	SPDT		10
	Sealed (Tape-sealed)		NRPS11-G□	NRPS11-G□PN10	1A, 1.6A, 2A, 3.15A, 4A, 5A, 6A	SPDT		10
NRPF (Flat)	Non-sealed		NRPF11-□	NRPF11-□PN10	1A, 1.6A, 2A, 3.15A, 4A, 5A, 6A	SPDT		10
	Sealed (Tape-sealed)		NRPF11-G□	NRPF11-G□PN10	1A, 1.6A, 2A, 3.15A, 4A, 5A, 6A	SPDT		10

Note: Terminal ③ on 1NC contact type is provided for firm mounting on printed-circuit boards, without internal connections.

Ordering Information

When ordering, select appropriate circuit protectors in consideration of the soldering method and necessity of cleaning.

NRP Series Circuit Protectors

Selection Guide - Select appropriate circuit protectors (marked with X in the table below) according to your application.

Applications	Slim		Flat	
	Non-sealed	Sealed	Non-sealed	Sealed
	NRPS10-□ NRPS11-□	NRPS10-G □ NRPS11-G □	NRPF10-□ NRPF11-□	NRPF10-G □ NRPF11-G □
Manual soldering	X	X	X	X
Dip soldering	—	X	—	X
Cleaning after soldering	—	X	—	X
Automatic mounting on PC boards	X	X	—	—

Note: The sealed type is provided with epoxy-seal on the base and a tape seal on the actuator side. After cleaning, be sure to remove the tape seal.

When using flux, use rosin flux. Select the sealed type irrespective of cleaning necessity.

Specifications

Protection Method	Thermal tripping
Internal Circuit	Series Trip
No. of Poles	1 pole
Rated Voltage	250V AC (50/60Hz), 32V DC
Rated Current	1A, 1.6A, 2A, 3.15A, 4A, 5A, 6A
Rated Interrupting Current	1 to 4A: Rated current x 10 (resistive load) 5 and 6A: 250V AC/40A, 32V DC/40A (resistive load)
Minimum Applicable Load	5V AC/DC 100 mA (reference value)
Reference Temperature	25°C
Operating Temperature (Note)	-10 to +50°C (no freezing)
Storage Temperature	-30 to +70°C (no freezing)
Operating Humidity	45 to 85% RH (no condensation)
Storage Ambient Humidity	45 to 85% RH (no condensation)
Vibration Resistance	100 m/sec ² (10 to 55 Hz)
Shock Resistance	Damage limits: 1000 m/s ² Operating extremes: 500 m/s ²
Life	200 operations (tripping at 200% the rated current)
Insulation Resistance	100 MΩ minimum (500V DC megger)
Dielectric Strength	1500V AC (50/60Hz), 1 minute (between terminals of the same pole when main contacts are open, and between live parts and ground)
Initial contact	Between terminals ① and ②: 200 mΩ maximum (5V DC · 1A) Between terminals ② and ③: 100 mΩ maximum (5V DC · 100mA)
Weight (Approx.)	2g

Note: The rated current is the value at the reference ambient temperature of 25°C, and varies with operating temperature. The rated current can be corrected according to the Temperature Correction Curve.

Time Delay Curves

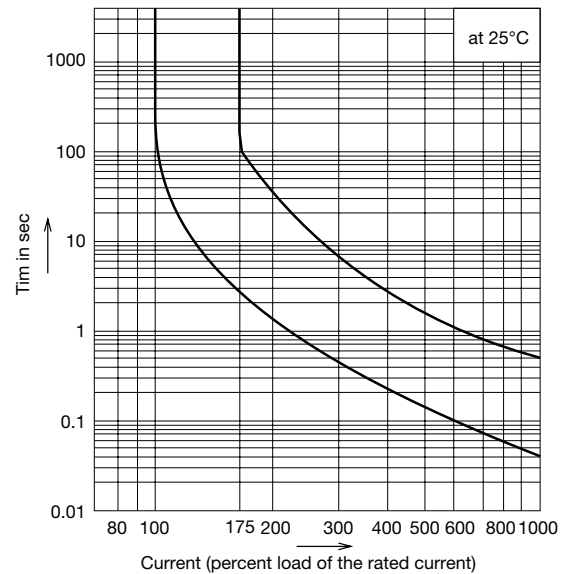

Temperature Correction Curve

The rated current is based on an ambient temperature of 25°C. Since a thermal tripping method is employed, the rated current should be corrected according to the ambient temperature with reference to the curve shown below.

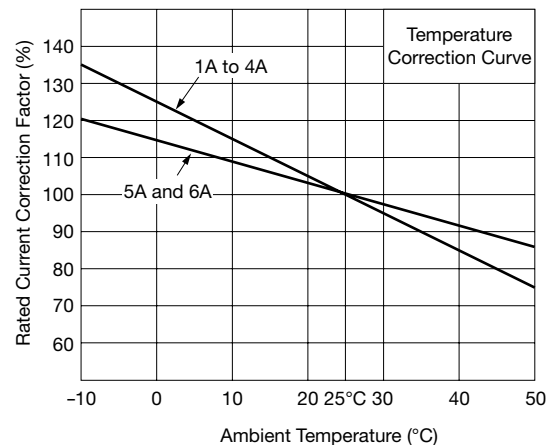

Overcurrent - Time Delay Characteristics (sec at 25°C)

Percent of Rated Current	100%	175%	200%	400%	600%	800%	1000%
Time Delay	No Trip	2.2-120	1.2-40	0.24-2.2	0.1-1	0.06-0.7	0.04-0.5

Dimensions and PC Board Drilling Layout

Slim

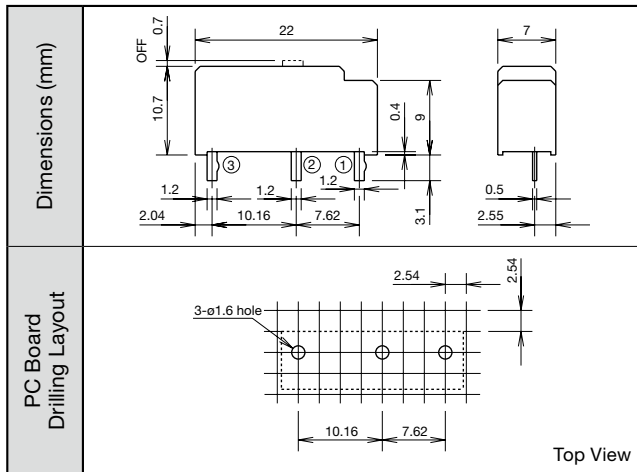

Flat

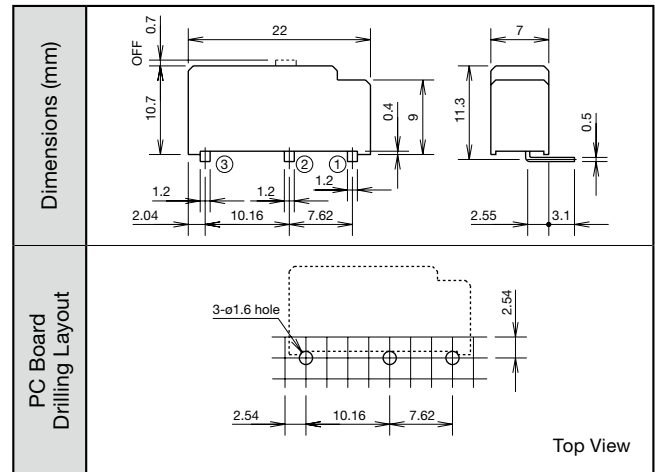

Applications of NRPS/NRPF Circuit Protectors

The NRPS/NRPF series circuit protectors are ideal for use on printed-circuit boards in small electric appliances to protect power transformers, rectifiers, small-motors, solenoid valves, and solenoids from overloads.

In addition to higher economic efficiency than that of fuses, the capability of over 200 repeated uses will find a wide range of applications in place of various fuses.

Applications Examples

Office Automation Equipment: Copiers, shredders, fax machines
 machine tools,

Tools: Hydraulic devices, robots, etc.

Measuring equipment: Testers, oscilloscopes, etc.

Communication Equipment: Transmitter/receiver,
 telephone exchanger

Power Supplies: Switching power supplies,
 small generators

Application Circuits Example

Transformer Protection Example

Transformer Primary Protection

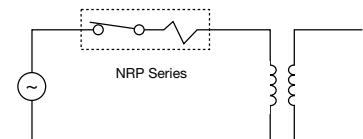

Transformer Secondary Protection

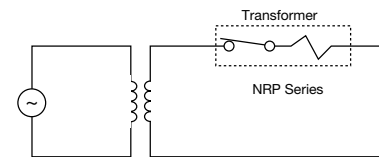

Rectifier Protection Example

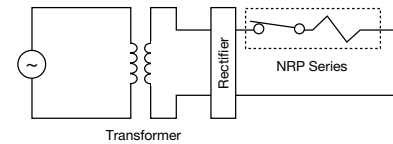

Motor Coil Protection

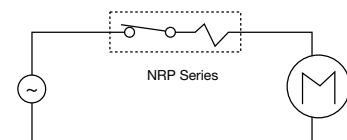

Safety Precautions

1. Soldering

Soldering to the printed-circuit boards

Soldering should be done quickly referring to the conditions below. If the terminals are heated excessively, the bimetal may trip.

Manual soldering

For manual soldering, complete soldering with a 60W soldering iron (soldering tip temp.: 350°C) quickly within 3 seconds. (When lead-free soldering is used, Sn-Ag-Cu is recommended.)

During soldering, keep the soldering iron away from the plastic housing of the circuit protector, and apply no external force by bending the terminal or pulling the wires. (Check your actual soldering conditions before soldering.)

Dip soldering

Dipping temperature: 260°C

Dipping duration: 5 seconds maximum

- Do not solder the sealed type in a flow soldering bath. Since preheating process weakens the viscosity of the tape seal on the actuator due to the air expansion inside NRPS and the NRPF, air-tightness is possibly lowered.
- For the non-sealed type, perform manual soldering. Do not use the water-soluble flux because it runs into the unit and it causes malfunctions.
- Non-corrosive rosin flux is recommended because washing is not required.

2. Washing

- When there is a possibility of washing, select the seal type.
- Washing should be done at 60°C maximum within 30 seconds (and 50mm depth for full washing). Avoid steam washing. Use pure water as a cleaning solvent. When an organic solvent is used, use of alcohol is recommended. Before using other organic solvents, make sure that after actual washing, the tape seal is not removed and sealant or housing material is not affected.
- The base of sealed type is provided with epoxy resin sealing and a tape seal covers the actuator. After cleaning, be sure to remove the tape from the actuator before use.

3. Notes for Bimetal

- Storage temperature should not exceed 70°C. If storage temperature exceeds 70°C, the bimetal may trip.
- Applied current should be under the rated current for the normal use. The rated current should be corrected according to the ambient temperature chart due to bimetal characteristics.
- Since the NRPS and NRPF are designed for protection against overloads, they should be used within the rated interrupting current. An excessive overcurrent may affect the bimetal characteristics or damage the internal mechanism.
- Note that the NRPS and NRPF do not respond to overcurrent for a period of few tens to few hundreds msec.

4. Manual OFF Mechanism

Manual OFF mechanism is performed by slightly pulling the white pin at the top of the unit with tweezers.

5. Other Notes

- Make sure that no load (current) is applied before resetting manually turning the circuit OFF with actuator operation. In addition, avoid frequent opening and closing of the actuator at no load (current is not applied).
- Turn power off and allow at least 60 seconds before re-throwing (at reference ambient temperature of 25°C). Reset the protector with no load. Do not press the actuator with something sharp, otherwise the internal part may be damaged.
- Do not hold the actuator depressed while an overcurrent is present, because the overcurrent may damage the circuit protectors.

Specifications and other descriptions in this brochure are subject to change without notice.



IDEC CORPORATION

6-64, Nishi-Miyahara 2-Chome, Yodogawa-ku, Osaka 532-0004, Japan
Tel: +81-6-6398-2527, Fax: +81-6-6398-2547
E-mail: marketing@idec.co.jp

IDEC CORPORATION (USA)

1175 Elko Drive, Sunnyvale, CA 94089-2209, USA
Tel: +1-408-747-0550 / (800) 262-IDEC (4332)
Fax: +1-408-744-9055 / (800) 635-6246
E-mail: opencontact@idec.com

IDEC CANADA LIMITED

3155 Pepper Mill Court, Unit 4
Mississauga, Ontario, L5L 4X7, Canada
Tel: +1-905-890-8561, Toll Free: (888) 317-IDEC (4332)
Fax: +1-905-890-8562
E-mail: sales@ca.idec.com

IDEC AUSTRALIA PTY. LTD.

Unit 17, 104 Ferntree Gully Road,
Oakleigh, Victoria 3166, Australia
Tel: +61-3-8523-5900, Toll Free: 1800-68-4332
Fax: +61-3-8523-5999
E-mail: sales@au.idec.com

IDEC ELEKTROTECHNIK GmbH

Heselstruecken 8, 22453 Hamburg, Germany
Tel: +49-40-25 30 54 - 0, Fax: +49-40-25 30 54 - 24
E-mail: service@eu.idec.com

IDEC (SHANGHAI) CORPORATION

Room 701-702 Chong Hing Finance Center,
No. 288 Nanjing Road West, Shanghai 200003, PRC
Tel: +86-21-6135-1515
Fax: +86-21-6135-6225 / +86-21-6135-6226
E-mail: idec@cn.idec.com

IDEC (BEIJING) CORPORATION

Room 211B, Tower B, The Grand Pacific Building,
8A Guanghua Road, Chaoyang District,
Beijing 100026, PRC
Tel: +86-10-6581-6131, Fax: +86-10-6581-5119

IDEC (SHENZHEN) CORPORATION

Unit AB-3B2, Tian Xiang Building, Tian'an Cyber Park,
Fu Tian District, Shenzhen, Guang Dong 518040, PRC
Tel: +86-755-8356-2977, Fax: +86-755-8356-2944

IDEC IZUMI (H.K.) CO., LTD.

Unit G & H, 26/F, MG Tower, No. 133 Hoi Bun Road,
Kwun Tong, Kowloon, Hong Kong
Tel: +852-2803-8989, Fax: +852-2565-0171
E-mail: info@hk.idec.com

IDEC TAIWAN CORPORATION

8F-1, No. 79, Hsin Tai Wu Road, Sec. 1,
Hsi-Chih District, 22101 New Taipei City, Taiwan
Tel: +886-2-2698-3929, Fax: +886-2-2698-3931
E-mail: service@tw.idec.com

IDEC IZUMI ASIA PTE. LTD.

No. 31, Tannery Lane #05-01,
HB Centre 2, Singapore 347788
Tel: +65-6746-1155, Fax: +65-6844-5995
E-mail: info@sg.idec.com

IDEC ASIA (THAILAND) CO.,LTD.

20th Fl., Sorachai Bldg., No.23/78,
Soi Sukhumvit 63, Sukhumvit Rd.,
Klongton-nua, Wattana, Bangkok 10110
Tel: +662-392-9765, Fax: +662-392-9768
E-mail: sales@th.idec.com

www.idec.com