

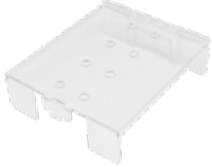

안전 단자대 H Type 용 악세사리

KTB1 시리즈

옵션품

형상	구분	품명	Pole수	적용 단자대
	H Type 보호 커버 ※ 난연등급(V2)	KTB1-060A3HC	3	KTB1-06003
		KTB1-060A4HC	4	KTB1-06004
		KTB1-100A3HC	3	KTB1-10003
		KTB1-100A4HC	4	KTB1-10004
		KTB1-150A3HC	3	KTB1-15003
		KTB1-150A4HC	4	KTB1-15004
		KTB1-200A3HC	3	KTB1-20003
		KTB1-200A4HC	4	KTB1-20004
	H Type 보호 커버 ※ 난연등급(V2)	KTB1-060BC	4	KTB1-06003 KTB1-06004
		KTB1-100BC	4	KTB1-10003 KTB1-10004
		KTB1-150BC	4	KTB1-15003 KTB1-15004
		KTB1-200BC	4	KTB1-20003 KTB1-20004

※ BC커버 사용시 단자대와 Pole 수가 다른 경우 BC커버를 원하는 Pole수 만큼 분리, 연결 하여 사용 하시면 됩니다.

외형치수도

단위 : mm

약세사리

H Type 안전 보호 커버

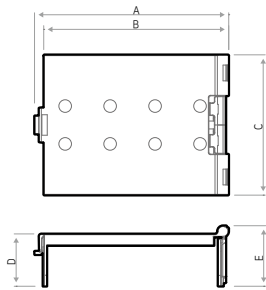

품명	A	B	C	D	E
KTB1-060A3HC	94.5	85.0	89.0	33.0	38.0
KTB1-060A4HC	123.0	117.5	89.0	33.0	38.0
KTB1-100A3HC	113.0	107.5	114.5	37.5	42.5
KTB1-100A4HC	147.0	141.5	114.5	37.5	42.5
KTB1-150A3HC	124.0	118.5	136.5	41.0	46.0
KTB1-150A4HC	163.0	157.0	136.5	41.0	46.0
KTB1-200A3HC	143.0	135.0	152.0	47.5	53.5
KTB1-200A4HC	187.0	179.0	152.0	47.5	53.5

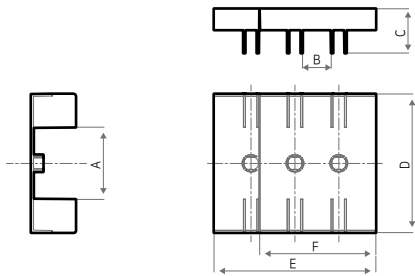

품명	A	B	C	D	E	F
KTB1-060BC	44	17.5	30.6	81	104	74.4
KTB1-100BC	55.2	23.2	33.6	105	125	90.8
KTB1-150BC	66.8	25.8	37.1	126	145	104.1
KTB1-200BC	73	28.9	45.2	141	165	118.6

4 Part

소형회로 차단기

퓨즈 & 퓨즈홀더

써지 보호기

음향 신호기

부저류

안전 단자대

고정식·조립식 단자대

시험 단자대

조립식 커먼 단자대

태양광 시스템

집합 표시등

시그널 타워

히터

온·습도 제어기기

수배전반용 조명등

케이블 그랜드



안전 단자대 C Type 용 악세사리

KTB 시리즈

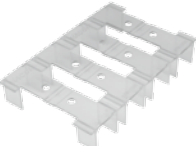
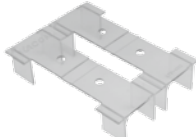
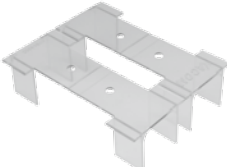
옵션품

형상	구분	품명	Pole수	적용 단자대
   		KTB1-010C	10	KTB1-01003 KTB1-01004 KTB1-01006 KTB1-01010
		KTB1-020C	10	KTB1-02003 KTB1-02004 KTB1-02006 KTB1-02010 KTB1-02012 KTB1-02015 KTB1-02020
		KTB1-030C	10	KTB1-03003 KTB1-03004 KTB1-03006 KTB1-03010
		KTB1-060C	4	KTB1-06003 KTB1-06004
		KTB1-100C	4	KTB1-10003 KTB1-10004
	절연벽형 보호 커버 ※ 난연등급(V2)	KTB1-150C	4	KTB1-15003 KTB1-15004
		KTB1-200C	4	KTB1-20003 KTB1-20004
		KTB1-400C	2	KTB1-30003 KTB1-30004
			2	KTB1-40003 KTB1-40004
		KTB1-600C	2	KTB1-50003 KTB1-50004
	2		KTB1-60003 KTB1-60004	

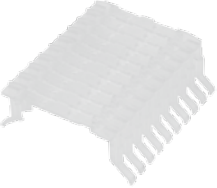
접선품

형상	구분	품명	Pole수	적용 단자대
	절연벽형 보호 커버 ※ 난연등급(V2)	KTB2-01010C	10	KTB2-010
		KTB2-01510C	10	KTB2-015
		KTB2-02510C	10	KTB2-025
		KTB2-03510C	10	KTB2-035
		KTB2-06010C	10	KTB2-060
		KTB2-10004C	4	KTB2-100
	절연벽형 보호 커버 ※ 난연등급(V2)	KTB3-01010C	10	KTB3-010
		KTB3-01510C	10	KTB3-015
	세퍼레이터	KTB2-A10 KTB2-A25 KTB2-A30 KTB2-A60 KTB2-A100	-	KTB2-010 KTB2-015, KTB2-025 KTB2-035 KTB2-060 KTB2-100
	세퍼레이터	KTB3-A10 KTB3-A15	-	KTB3-010 KTB3-015

4 Part

소형회로 차단기

퓨즈 & 퓨즈홀더

써지 보호기

음향 신호기

부저류

안전 단자대

고정식·조립식 단자대

시험 단자대

조립식 커먼 단자대

태양광 시스템

집합 표시등

시그널 타워

히터

온·습도 제어기기









수배전반용 조명등

케이블 그랜드

안전 단자대 C Type 용 악세서리

KTB 시리즈

읍선평

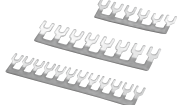
형상	구분	품명	적용 품목
	고정 브라켓 ※ 난연등급 (V2)	KTB1-BKT	KTB1-010C, KTB1-020C, KTB1-030C
	고정 캡 ※ 난연등급 (V2)	KTB1-CAP	KTB1-060C, KTB1-100C, KTB1-150C, KTB1-200C, KTB1-400C, KTB1-600C
	스토퍼	KTB2-STA (15mm용)	KTB2-CHA
	스토퍼	KTB2-STB (35mm용)	KTB2-CHB, KTB2-CHC
	스토퍼	KTB2-STC (35mm용 / 플라스틱)	KTB2-CHB, KTB2-CHC
	15mm 채널	KTB2-CHA (기본 1M) KTB2-CHA-2M	KTB2-010 / KTB3-010
	35mm 채널	KTB2-CHB (기본 1M) KTB2-CHB-2M	KTB2-015 ~ 100 / KTB3-015
	35mm 채널 / 커팅형	KTB2-CHC (기본 1M) KTB2-CHC-2M	KTB2-015 ~ 100 / KTB3-015
	쇼트바 (안전 보호 커버 전용) ※ 색상 : B-Blue, K-Black, R-Red, Y-Yellow	KTB2-S1010 KTB2-S1510 KTB2-S2510 KTB2-S3510	KTB2-010C KTB2-015C KTB2-025C KTB2-035C
		KTB3-S1010 KTB3-S1510	KTB3-010C KTB3-015C
	쇼트바 ※ 색상 : B-Blue, K-Black, R-Red, Y-Yellow	KTB2-S1512 KTB2-S2506 KTB2-S3508	KTB2-015C KTB2-025C KTB2-035C
		KTB3-S1512	KTB3-015C

외형치수도

단위 : mm

고정식 단자대 안전 보호 커버

KTB1-010C

KTB1-020C

KTB1-030C

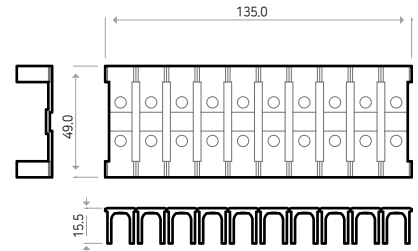
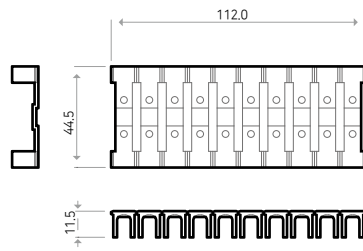
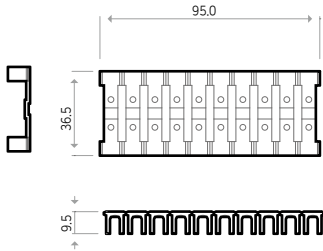

KTB1-060C

KTB1-100C

KTB1-150C

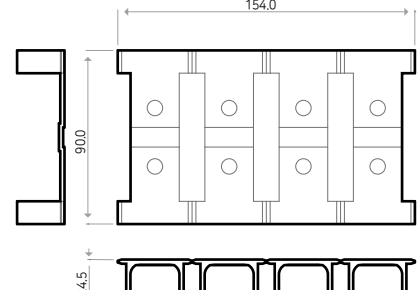
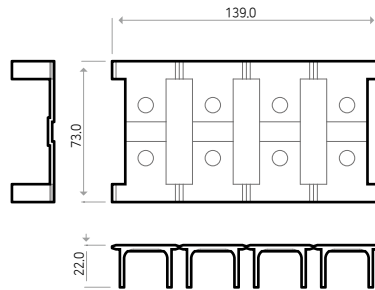
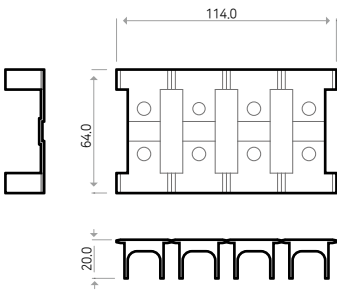

KTB1-200C

KTB1-400C

KTB1-600C

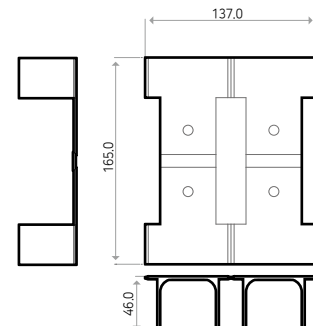
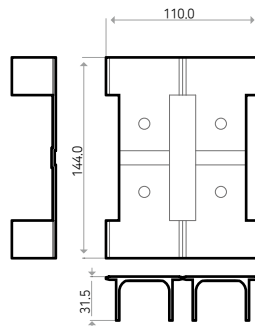
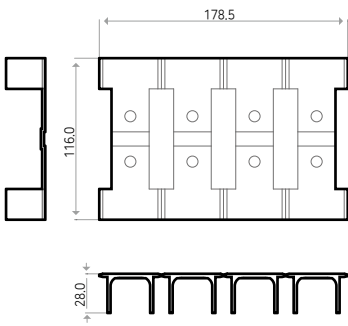

4 Part

소형회로 차단기

퓨즈 & 퓨즈홀더

써지 보호기

음향 신호기

부저류

안전 단자대

고정식·조립식 단자대

시험 단자대

조립식 커먼 단자대

태양광 시스템

집합 표시등

시그널 타워

히터

온·습도 제어기기

수배전반용 조명등

케이블 그랜드

안전 단자대 C Type 용 악세사리

KTB 시리즈

외형치수도

단위 : mm

조립식 단자대

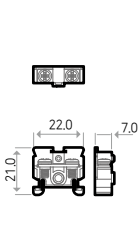
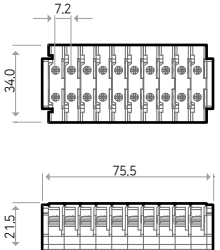
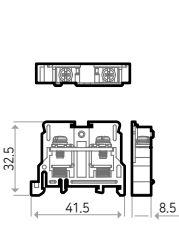
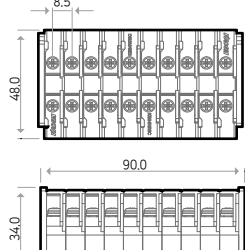
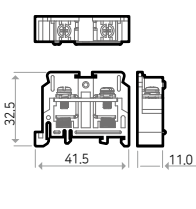
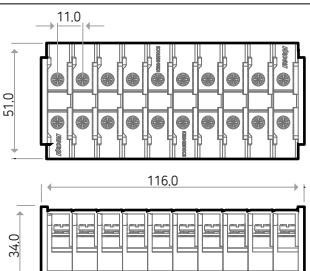
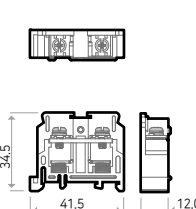
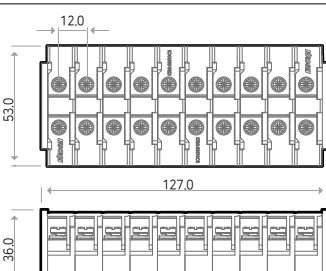
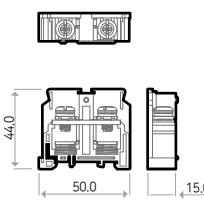
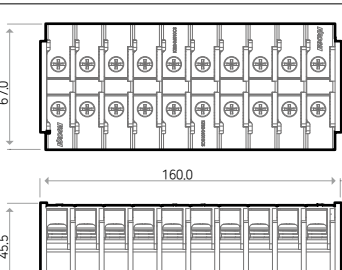
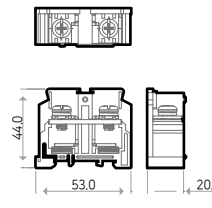
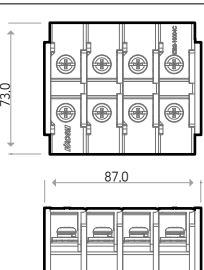
KTB2-010	KTB2-010-C	KTB2-015	KTB2-015-C
			
KTB2-025	KTB2-025-C	KTB2-035	KTB2-035-C
			
KTB2-060	KTB2-060-C	KTB2-100	KTB2-100-C
			

2단 조립식 단자대

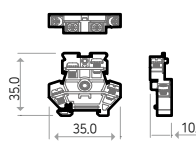
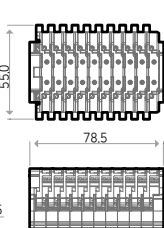
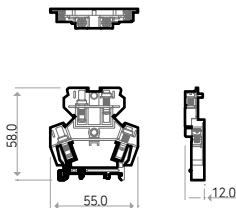
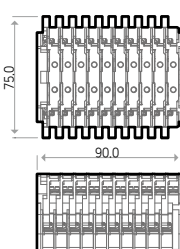
KTB3-010	KTB3-010-C	KTB3-015	KTB3-015-C
			

외형치수도

단위 : mm

약세사리

KTB1-C Type 안전 보호 커버

KTB2-C Type 안전 보호 커버

KTB2-10004C

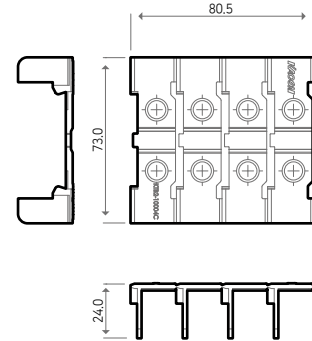
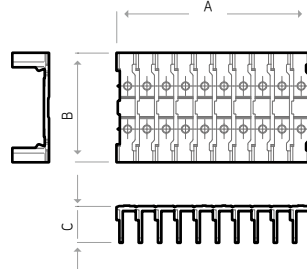
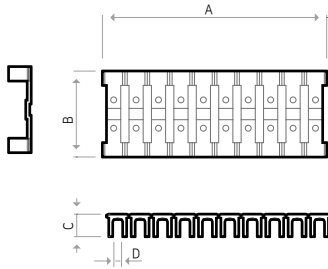

품명	A	B	C	D
KTB1-010C	95.0	36.5	9.5	4.5
KTB1-020C	112.0	44.5	11.5	6.0
KTB1-030C	135.0	49.0	15.5	8.5
KTB1-400C	110.0	144.0	31.5	36.0
KTB1-600C	137.0	165.0	46.0	44.5

품명	A	B	C
KTB2-01010C	71.5	34.0	11.5
KTB2-01510C	85.0	48.0	16.0
KTB2-02510C	111.0	51.0	15.9
KTB2-03510C	121.5	53.0	16.3
KTB2-06010C	154.0	69.0	23.5

KTB3-01010C

KTB3-01510C

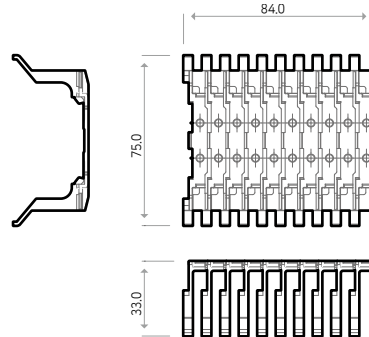
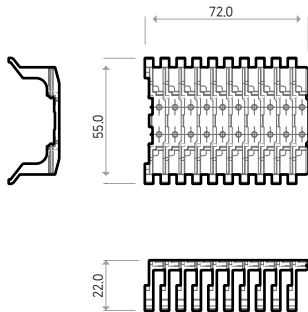

KTB1-BKT

KTB1-CAP

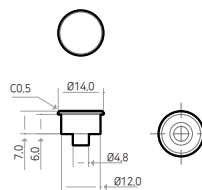
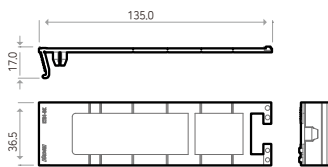

4 Part

소형회로 차단기

퓨즈 & 퓨즈홀더

써지 보호기

음향 신호기

부저류

안전 단자대

고정식·조립식 단자대

시험 단자대

조립식 커먼 단자대

태양광 시스템

집합 표시등

시그널 타워

히터

온·습도 제어기기

수배전반용 조명등

케이블 그랜드

안전 단자대 C Type 용 악세사리

KTB 시리즈

외형치수도

단위 : mm

악세사리

쇼트바

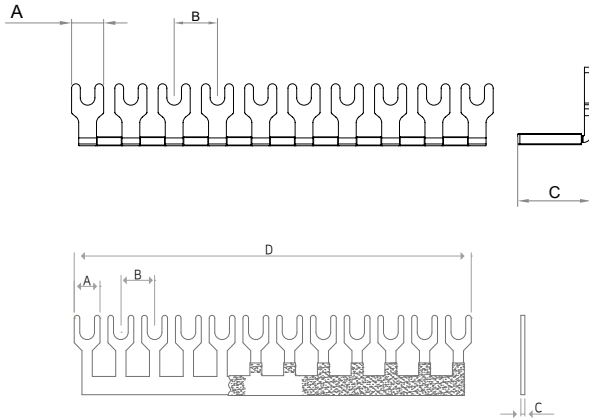

품명	A	B	C
KTB2-S1010	5	7.2	11
KTB2-S1510	6.5	8.5	12.5
KTB2-S2510	8.5	11.1	16
KTB2-S3510	9.0	12.2	16.5
KTB3-S1010	5.5	7	8
KTB3-S1510	6.3	8.15	10.5

품명	A	B	C	D
KTB2-S1512(12P)	6.2	8.4	0.8	11
KTB2-S2506(6P)	8.1	11.0	0.8	12.5
KTB2-S3508(8P)	8.1	12.0	1.0	16
KTB3-S1512(12P)	6.3	8.0	0.8	16.5

찬넬

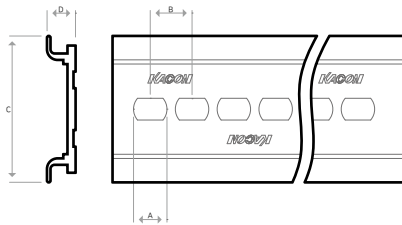

품명	A	B	C	D
KTB2-CHA	8.0	13.8	15.0	5.0
KTB2-CHB	8.0	14.0	35.0	7.0
KTB2-CHC	8.0	13.7	35.0	7.0

스토퍼

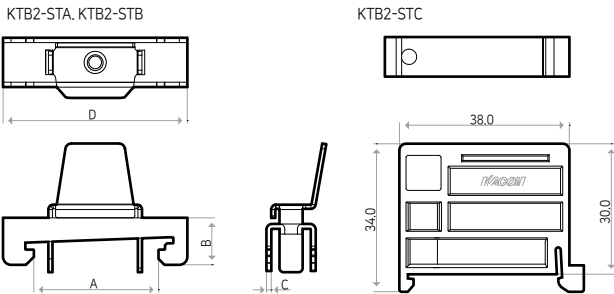

	KTB2-StA	KTB2-StB
A	13.2	31.5
B	8.5	12.0
C	1.2	1.2
D	21.0	46.5

세퍼레이터

KTB2-A Series

KTB3-A Series

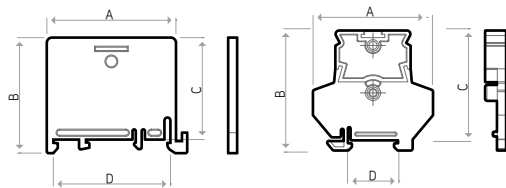







품명	A	B	C	D
KTB2-A10	22.0	21.0	17.5	15.0
KTB2-A25	38.0	34.0	30.0	35.0
KTB2-A35	38.0	36.0	32.0	35.0
KTB2-A60	48.0	45.0	41.0	35.0
KTB2-A100	51.0	45.0	41.0	35.0
KTB3-A10	35.0	35.0	32.0	15.0
KTB3-A15	55.0	58.0	54.0	35.0

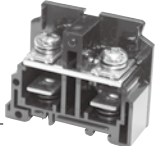
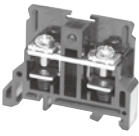

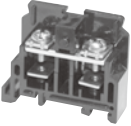
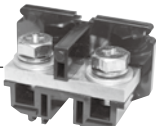
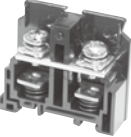

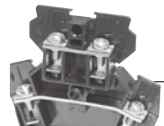









조립식 단자대

KTB2, KTB3 시리즈

제품구분도

	정격전류	터미널 볼트	Torque	품명		정격전류	터미널 볼트	Torque	품명
	10A	M3.0	0.5	KTB2-010		60A	M6.0	2.5	KTB2-060
	15A	M3.5	0.8	KTB2-015		100A	M6.0	2.5	KTB2-100
	25A	M4.0	1.2	KTB2-025		200A	M10.0	4.0	KTB2-200
	35A	M4.0	1.2	KTB2-035		300A	M12.0	14.0	KTB2-300
						10A	M3.0	0.5	KTB3-010
						15A	M3.5	0.8	KTB3-015

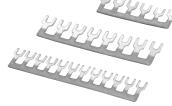
옵션

채널		세퍼레이터		
KTB2-CHA (기본1M) KTB2-CHA-2M  15mm용	KTB2-CHB (기본1M) KTB2-CHB-2M  35mm용	KTB2-CHC (기본1M) KTB2-CHC-2M  35mm용(컷팅형)	KTB2-A10 ~ A300 	
세퍼레이터		스토퍼		
KTB3-A10  15mm용	KTB3-A15  35mm용	KTB2-STA  15mm용	KTB2-STB  35mm용	KTB2-STC  35mm용 (Plastic)
커버		기명판		쇼트바
KTB2-CVA(10A)  ※ 난연등급(V2)	KTB2-CVB (15 ~ 35A) KTB2-CVC (60 ~ 100A)  ※ 난연등급(V2)	KTB2-PA (10A용) KTB2-PB (15A 이상용) 	KTB2 - S1512 □, KTB2 - S2506 □, KTB2 - S3508 □, KTB3-S1512 □ 	KTB2-S1010 □ KTB3-S1010 □ 

☞ Color : R(적색), Y(황색), K(흑색), B(청색)

4 Part

회로
보호기
CP

소형회로
차단기

퓨즈 &
퓨즈홀더

써지
보호기

음향
신호기

부저류

안전
단자대

고정식·
조립식
단자대

시험
단자대

태양광
시스템

집합
표시등

시그널
타워

히터

온·습도
제어기기

수배전반용
조명등

케이블
그랜드