

제어용 스위치 악세서리

Ø16, 19, 20

옵션

구분 및 형상	사용 홀치수 & 전압	색상	모델	T	적용 시리즈				
					Ø16 K	Ø16 F	Ø16 M	Ø20 매입형 K	Ø20 매입형 F
투명 보호 커버 	Ø16	투명	T16-C	○	-	-	-	-	-
	Ø19	투명	T19-C	○	-	-	-	-	-
	Ø22	투명	T22-C	○	-	-	-	○	○
※ T□ -C 보호 커버는 PL / PB / PBL만 적용 가능합니다.									
정사각 보호커버 - 박스형 	Ø16	□ : 무표시(흑색) R(적색) G(녹색) Y(황색)	K16-S111□	○	○	○ (EPB제외)	-	-	-
직사각 보호커버 - 박스형 	Ø16	□ : 무표시(흑색) R(적색) G(녹색) Y(황색)	K16-S112□	○	○	○ (EPB제외)	-	-	-
정사각 보호커버 - 사이드 오픈/ 스프링형 	Ø16	□ : 무표시(흑색) R(적색) G(녹색) Y(황색)	K16-S221□	○	○	-	-	-	-
직사각 보호커버 - 사이드 오픈/ 스프링형 	Ø16	□ : 무표시(흑색) R(적색) G(녹색) Y(황색)	K16-S222□	○	○	-	-	-	-
보호 가드 	Ø16	황색	K16-G1	-	○	○ (EPB 제외)	-	-	-
보호 가드 	Ø16	황색	K16-G2	-	○	○ (EPB 제외)	-	-	-
LED	24V AC/DC 12V AC/DC 6V AC/DC	□ : R(적색) G(녹색) Y(황색) W(백색) B(청색)	-	-	K16-S115□	-	-	K16-S115□	-
	24V AC/DC 12V AC/DC 6V AC/DC	□ : R(적색) G(녹색) Y(황색) W(백색) B(청색)	-	-	-	F16-S115□	-	-	F16-S115□

접선

구분 및 형상	사용 홀치수 & 전압	색상	모델	T	적용 시리즈					
					Ø16 K	Ø16 F	Ø16 M	Ø20 매입형 K	Ø20 매입형 F	
220VAC 트랜스		220VAC	흑색	-	-	K16-T1	F16-T1	-	K16-T1	F16-T1
Ø16 Hole Cover		Ø16	흑색	K16-S117	○	○	○	○	-	-
고정링 조임공구		-	흑색	K16-W1	-	○	○	-	○	○
LED 교환공구		-	흑색	K16-LR1	-	○	-	-	○	-
소켓 (Soldering)		-	흑색	K16-S113	○	○	-	-	○	-
소켓 (PCB)		-	흑색	K16-S114	○	○	-	-	○	-
접점블럭 1N/O + 1N/C			흑색	FCB	-	-	○	-	-	○
공블럭			흑색	FEB	-	-	○	-	-	○
단자 보호커버				F16-S116	○	-	○	-	-	○
		Ø16	흑색	T16-S07 T16-S11 T16-S21 T16-S17 T16-S27	○	-	-	-	-	-
커넥터		Ø19	흑색	T19-S07 T19-S11 T19-S17	○	-	-	-	-	-
		Ø19, Ø22 (겸용)	흑색	T19-D11 T19-D21 T19-D17 T19-D27	○	-	-	-	-	-

Ø22

Ø25







Ø30

도면

제어용 스위치 악세서리

Ø22, 25, 30용 보호가커버 & 가드

옵션

구분 및 형상	사용 출치수	색상	모델	J2	T	적용 시리즈						
						Ø25 매입형 K25F	Ø30 매입형 K30F	Ø25 AL가드 K25F-AL	K22-91	K	B	KEX
투명 보호커버 <small>※ T□ -C 보호 커버는 PL / PB / PBL만 적용 가능합니다.</small>		Ø22	투명	T22-C	-	○	-	-	-	-	-	-
		Ø25	투명	T25-C	-	○	○	-	-	-	-	-
		Ø30	투명	T30-C	-	○	-	○	-	-	-	-
보호커버		Ø22	-	SC2	-	-	-	-	-	○	-	-
		Ø25	-	SC5	-	-	-	-	-	○	○	-
보호커버		Ø22	흑색	KSC12	-	-	-	-	-	○	-	-
		Ø25	흑색	KSC15	-	-	-	-	-	○	○	-
		Ø30	흑색	KSC13	-	-	-	-	-	○	○	-
원형방수커버 Ø40 플러그드용		Ø22 Ø25 Ø30		HP100	-	-	-	-	-	○	○	-
방진, 방유, 방수커버 Ø65용	 (Rubber NBR) Ø80 x 35	Ø22 Ø25 Ø30	□ :	HP120□	-	-	-	-	-	○	○	-
원형방수커버		Ø25		RCR	-	-	-	-	-	○	-	-
사각방수커버		Ø25		RCS	-	-	-	-	-	○	-	-

Ø16

Ø19

Ø20





범용선

구분 및 형상	사용 출치수	색상	모델	J2	T	적용 시리즈							
						Ø25 매입형 K25F	Ø30 매입형 K30F	Ø25 AL가드 K25F-AL	K22-91	K	B	KEX	
	Ø22	□ : Y(황색) R(적색)	KEG12 □	○	-	-	-	-	○	○	-	-	Ø22
	Ø25	G(녹색) A(호박색)	KEG15 □	-	-	○	-	○	-	○	○	-	Ø25
	Ø30	W(백색)	KEG13 □	-	-	-	○	-	-	○	○	-	Ø30
	Ø22	□ : R(적색)	KEG32 □	-	-	-	-	-	-	○	-	-	
	Ø25	Y(황색) G(청색) K(흑색) C(투명)	KEG35 □	-	-	○	-	-	-	○	○	-	
	Ø30		KEG33 □	-	-	-	○	-	-	○	○	-	도면
	Ø22		KEG42	○	-	-	-	-	-	○	-	-	
	Ø25	투명	KEG45	-	-	○	-	-	-	○	○	-	
	Ø30	(EPB/MPB제외)	KEG43	-	-	-	○	-	-	○	○	-	

제어용 스위치 악세서리

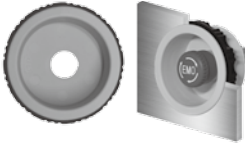
Ø22, 25, 30용 명판 & 박스

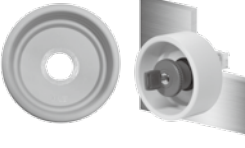
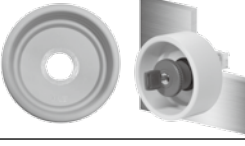
옵션

구분 및 형상	사용 출치수	색상	모델	J2	T	적용 시리즈						
						Ø25 매입형 K25F	Ø30 매입형 K30F	Ø25 AL가드 K25F-AL	K22-91	K	B	KEX
	Ø22		KEG72	○	-	-	-	-	○	○	-	-
	Ø25	황색	KEG75	-	-	-	-	-	-	○	○	-
	Ø30		KEG73	-	-	-	-	-	-	○	○	-
	Ø22		KEG72W	○	-	-	-	-	○	○	-	-
	Ø25	백색	KEG75W	-	-	-	-	-	-	○	○	-
	Ø30		KEG73W	-	-	-	-	-	-	○	○	-
	Ø22		KEG82	○	○	-	-	-	○	○	-	-
	Ø25	황색	KEG85	-	○	-	-	-	-	○	○	-
	Ø30		KEG83	-	○	-	-	-	-	○	○	-
	Ø22	백색	KEG82W	○	○	-	-	-	○	○	-	-
	Ø22		KEG92	○	○	-	-	-	○	○	-	-
	Ø25	황색	KEG95	-	○	-	-	-	-	○	○	-
	Ø30		KEG93	-	○	-	-	-	-	○	○	-
	Ø22		KEG92W	○	○	-	-	-	○	○	-	-
	Ø25	백색	KEG95W	-	○	-	-	-	-	○	○	-
	Ø30		KEG93W	-	○	-	-	-	-	○	○	-

※ KEG8은 HP119 시리즈와 결합이 가능 합니다.
- 사용예





Ø16

Ø19

Ø20

명판

구분 및 형상	사용 홀치수	색상	모델	J2	T	적용 시리즈							
						Ø25 매입형 K25F	Ø30 매입형 K30F	Ø25 AL가드 K25F-AL	K22-91	K	B	KEX	
	Ø25	흑색	HP110A	-	-	-	-	-	-	○	-	-	
	Ø30	흑색	HP110B	-	-	-	-	-	-	○	-	-	
	Ø25	제품 : 황색 글자 : 흑색	HP111	-	-	-	-	-	-	○	○	-	
			HP112	-	-	-	-	-	-	○	○	-	
		Ø22		HP117A	-	-	-	-	-	○	○	-	-
		Ø25	제품 : 황색 글자 : 흑색	HP117B	-	-	-	-	-	-	○	○	-
Ø30			HP117C	-	-	-	-	-	-	○	○	-	
	Ø22		HP118A	-	-	-	-	-	○	○	-	-	
	Ø25	제품 : 황색 글자 : 흑색	HP118B	-	-	-	-	-	-	○	○	-	
	Ø30		HP118C	-	-	-	-	-	-	○	○	-	

Ø22

Ø25

Ø30

도면

제어용 스위치 약세서리

Ø22, 25, 30

옵션

구분 및 형상	사용 홀치수 & 전압	색상	모델	적용 시리즈											
				J2	T	Ø25 매입형 K25F	Ø30 매입형 K30F	Ø25 AL가드 K25F-AL	K22-91	K	B	KEX			
명판		제품 : 황색 글자 : 흑색	HP119E												
			HP119K	○	-	-	-	-	○	○	○	-			
			HP119C												
		Ø22 Ø25 Ø30 공용	제품 : 황색 글자 : 적색	HP119E-R	○	-	-	-	-	○	○	○	-		
				제품 : 백색 글자 : 흑색	HP119E- W(STOP)	○	-	-	-	-	○	○	○	-	
					HP119E- W(STOP-R)	○	-	-	-	-	○	○	○	-	
		제품 : 황색 글자 : 흑색	HP119E(OFF)	○	-	-	-	-	○	○	○	-			
			Ø22 Ø25 Ø30 공용	제품 : 황색 글자 : 적색	HP119E(OFF-R)	○	-	-	-	-	○	○	○	-	
					제품 : 백색 글자 : 흑색	HP119E-W(OFF)	○	-	-	-	-	○	○	○	-
		공용	제품 : 백색 글자 : 적색	HP119E- W(OFF-R)		○	-	-	-	-	○	○	○	-	
					제품 : 황색 글자 : 흑색	HP119E-1(STOP)	○	-	-	-	-	○	○	○	-
						Ø22 Ø25 Ø30 공용	제품 : 백색 글자 : 흑색	HP119E- 1W(STOP)	○	-	-	-	-	○	○
공용	제품 : 황색 글자 : 적색	HP119E- 1(STOP-R)	○	-	-			-	-	○	○	○	-		
			Ø22	제품 : 황색 글자 : 흑색	HP119E-1(OFF)	○	-	-	-	-	○	○	○	-	
Ø25 Ø30 공용	제품 : 황색 글자 : 적색				HP119E- 1(OFF-R)	○	-	-	-	-	○	○	○	-	
			공용	제품 : 백색 글자 : 흑색	HP119E- 1W(OFF)	○	-	-	-	-	○	○	○	-	
박스					Ø22	황색	KEX-101Y	○	-	-	-	-	-	-	-

※KEX-101Y는 HP119 시리즈와 결합이 가능합니다.

- 사용예

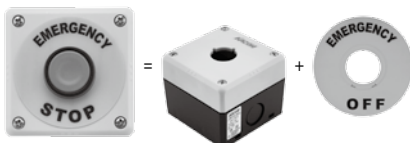











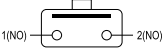
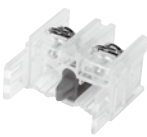

Ø16

Ø19

Ø20

단위 : mm

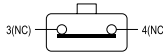
구분 및 형상	사양	모델	J2	T	적용 시리즈							
					Ø25 매입형 K25F	Ø30 매입형 K30F	Ø25 AL가드 K25F-AL	K22-91	K	B	KEX	
1NO 접점			CBA	-	-	○	○	○	○	○	-	-
			J2-10	○	-	-	-	-	-	-	-	-
1NO 접점		BCA (일반용) BCA-G (비상용)	-	-	-	-	-	-	-	-	○	-
			KEX-CB10	-	-	-	-	-	-	-	-	○
1NC 접점		 AC15 DC13 ※ 직접개방동작방식	CBB	-	-	-	○	○	○	○	-	-
			J2-01	○	-	-	-	-	-	-	-	-
1NC 접점		BCB (일반용) BCB-G (비상용)	-	-	-	-	-	-	-	-	○	-
			KEX-CB01	-	-	-	-	-	-	-	-	○

Ø22

Ø25

Ø30







도면

제어용 스위치 약세서리

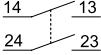
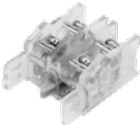
Ø22, 25, 30

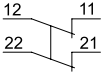
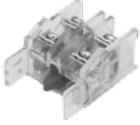
옵션

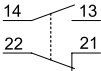
단위 : mm

구분 및 형상	사양	모델	J2	T	적용 시리즈						
					Ø25 매입형 K25F	Ø30 매입형 K30F	Ø25 AL가드 K25F-AL	K22-91	K	B	KEX
2NO 접점	 	J2-S20	○	-	-	-	-	-	-	-	-
	 	CBA2	-	-	0	0	0	0	0	-	-
2NC 접점	 	J2-S20	○	-	-	-	-	-	-	-	-
	  AC15 DC13 ※직접개방동작방식	CBB2	-	-	0	0	0	0	0	-	-
1NO + 1NC	 	J2-S11	○	-	-	-	-	-	-	-	-
	  AC15 DC13 ※직접개방동작방식	CBC	-	-	0	0	0	0	0	-	-











필라멘트

구분 및 형상	사양	모델	J2	T	적용 시리즈						
					Ø25 매입형 K25F	Ø30 매입형 K30F	Ø25 AL가드 K25F-AL	K22-91	K	B	KEX
필라멘트	6.3V AC/DC (220VAC, 110VAC용)	BA7S (조광 선택터)	-	-	-	-	-	-	○	-	-
	24V AC/DC (24VDC용)	BA9S (조광 선택터 外)	-	-	-	-	-	-	○	-	-
	Ⓐ - 색상 : R(적색), G(녹색), Y(황색), B(청색), W(백색), K(흑색)	BA7S-KⒶ (조광 선택터)	-	-	-	-	-	-	○	-	-
	6.3V AC/DC (220VAC, 110VAC용)	BA9S-KⒶ (조광 선택터 外)	-	-	-	-	-	-	○	-	-
LED	Ⓐ - 색상 : R(적색), G(녹색), Y(황색), B(청색), W(백색)	BA9S-JⒶ	○	-	-	-	-	-	-	-	-
	6V AC/DC, 12V AC/DC, 24V AC/DC, 110V AC/ DC, 220V AC/DC										
	Ⓐ - 색상 : R(적색), G(녹색), Y(황색), B(청색), W(백색), K(흑색)	BA9S-BⒶ	-	-	-	-	-	-	-	○	-
	24V AC/DC										
LED Trans	X1—⊗—X2										
	Ⓐ - 색상 : R(적색), G(녹색), Y(황색), B(청색), W(백색)	KT-Ⓐ	-	-	○	○	○	-	-	-	-
	12/24VDC 110VDC 110/220VAC										

제어용 스위치 악세서리

Ø22, 25, 30용 명판 & 박스

옵션

구분 및 형상	사양	모델	J2	T	적용 시리즈							
					Ø25 매입형 K25F	Ø30 매입형 K30F	Ø25 AL가드 K25F-AL	K22-91	K	B	KEX	
자기유지 Holder		KAL	-	-	○	○	○	-	○	-	-	
홀타입 접점안전커버		투명	KP-10	-	-	○	○	○	○	○	-	-
밀폐타입 접점안전커버		투명	KP-11	-	-	○	○	○	○	○	-	-
홀타입 트렌스 안전커버		투명	KP-20	-	-	○	○	○	○	○	-	-
밀폐타입 트렌스 안전커버		투명	KP-21	-	-	○	○	○	○	○	-	-
홀타입 접점안전커버 (CBA2,CBB2, CBC용)		투명	KP-30	-	-	○	○	○	○	○	-	-
밀폐타입 접점안전커버 (CBA2,CBB2, CBC용)		투명	KP-30	-	-	○	○	○	○	○	-	-
Ø19 커넥터		흑색	T19-S07 T19-S11 T19-S17	-	○	-	-	-	-	-	-	-
Ø19,Ø22 커넥터 (겸용)		흑색	T19-D11 T19-D21 T19-D17 T19-D27	-	○	-	-	-	-	-	-	-
Ø 22 커넥터		흑색	T22-S07 T22-S11 T22-S17	-	○	-	-	-	-	-	-	-
Ø 25, Ø 30 커넥터 (겸용)		흑색	T25-D07 T25-D11 T25-D21 T25-D17 T25-D27	-	○	-	-	-	-	-	-	-

제어용 스위치 악세서리

Ø16, 19, 20

Ø16

Ø19

외형치수도

단위 : mm

Ø20

T Series 보호커버

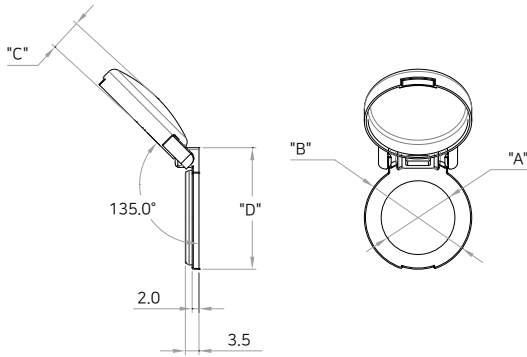

Model	A	B	C	D
T16-C	Ø16.5	Ø28.5	8.0	32.5
T19-C	Ø19.5	Ø28.5	8.0	32.5
T22-C	Ø22.5	Ø36.0	8.5	40.0
T25-C	Ø25.5	Ø36.0	8.5	40.0
T30-C	Ø30.5	Ø40.0	8.5	44.0

Ø22

Ø25

Ø30

K16 - S111

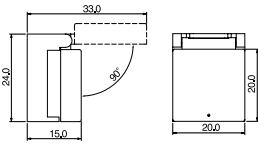

K16 - S112

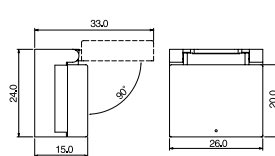

K16 - S221

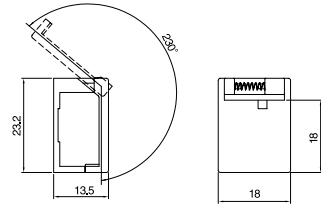

K16 - S222

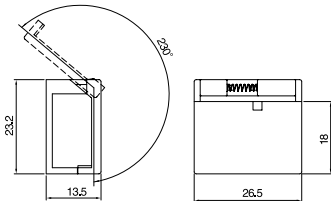

K16 - G1

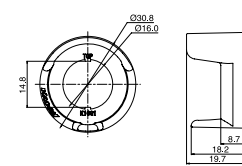

K16 - G2

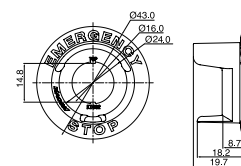

K16 - S115

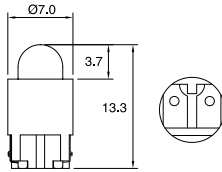

F16 - S115 / LED

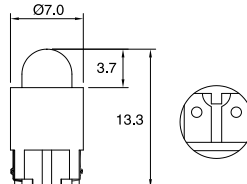

K16 - S117

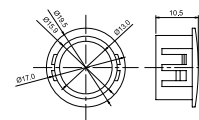

K16 - W1

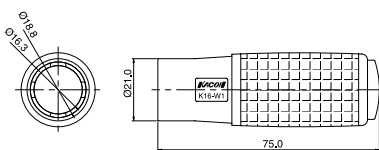

K16 - LR1

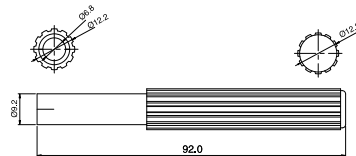

K16 - S113

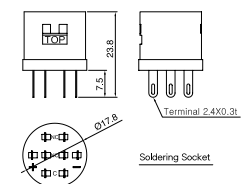

제어용 스위치 약세서리

Ø16, 19, 20

외형치수도

단위 : mm

K16 - T1 / 220VAC 트랜스

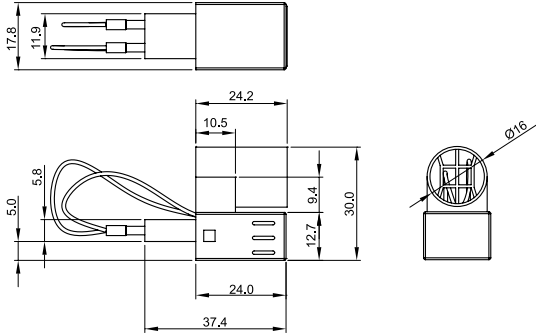

F16 - T1 / 220VAC 트랜스

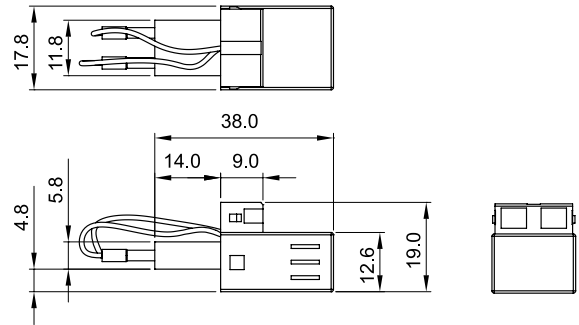

K16 - S114

FCB / 접점 블록 (1N/O + 1N/C)

FEB / 공블럭

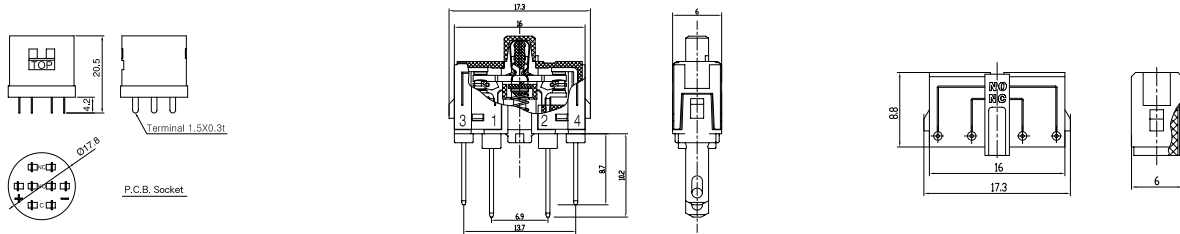

F16 - S116 / Terminal Protection

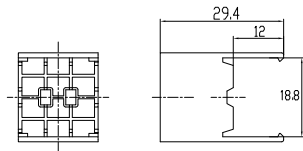

제어용 스위치 약세서리

Ø22, 25, 30

Ø16

Ø19

외형치수도

단위 : mm

Ø20

SC2, SC5

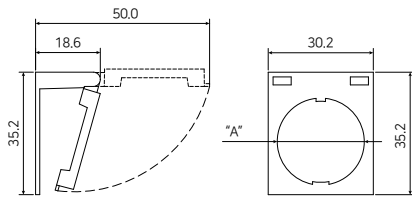

Model	"A"
SC2	Ø22
SC5	Ø25

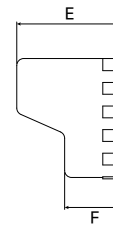

model	KSC12	KSC15	KSC13
Ø22	Ø22	Ø25	Ø30
B	19.0	22.0	26.0
C	Ø31.0	Ø35.0	Ø42.0
D	Ø22	Ø25	Ø30
E	27.0	31.0	37.0
F	15.0	17.0	20.5

Ø22

Ø25

Ø30

KEG12 / 15 / 13

KEG32 / 35 / 33

KEG42 / 45 / 43

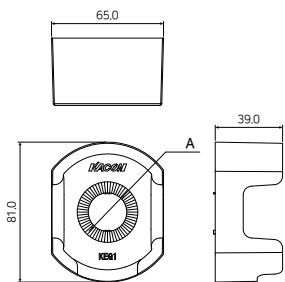

Model	"A"	Color
KEG12	Ø22	적색, Green Orange, Blue
KEG15	Ø25	
KEG13	Ø30	

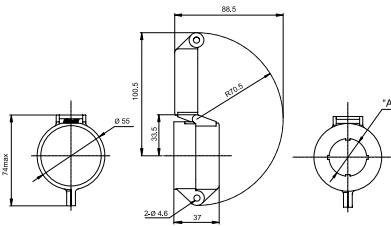

Model	"A"	Color
KEG32	Ø22	적색, Green Orange, Blue Clear, 흑색(K)
KEG35	Ø25	
KEG33	Ø30	

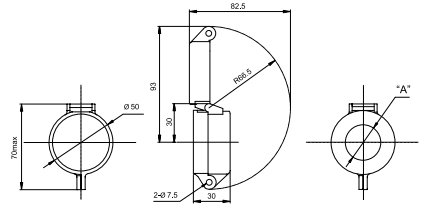

Model	"A"	Color
KEG42	Ø22	적색, Green Orange, Blue Clear, 흑색(K)
KEG45	Ø25	
KEG43	Ø30	

HP110A / HP110B

HP117A / 117B / 117C

HP118A / 118B / 118C

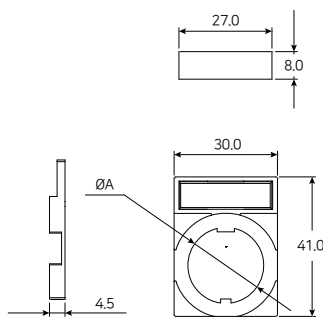

A	HP110A Ø22
	HP110B Ø25

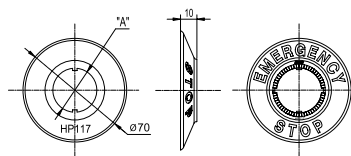

Model	"A"	Color
HP117A	Ø22	황색
HP117B	Ø25	
HP117C	Ø30	

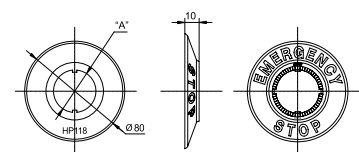

Model	"A"	Color
HP118A	Ø22	황색
HP118B	Ø25	
HP118C	Ø30	

도면

제어용 스위치 악세서리

Ø22, 25, 30

외형치수도

단위 : mm

KEG7 시리즈

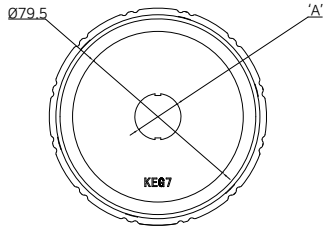
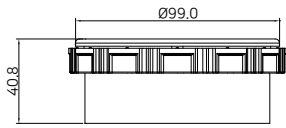

Model	'A'
KEG72	Ø22
KEG75	Ø25
KEG73	Ø30

KEG8 시리즈

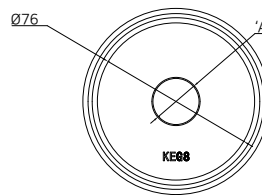
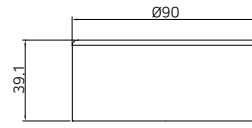

Model	'A'
KEG82	Ø22
KEG85	Ø25
KEG83	Ø30

KEG9 시리즈

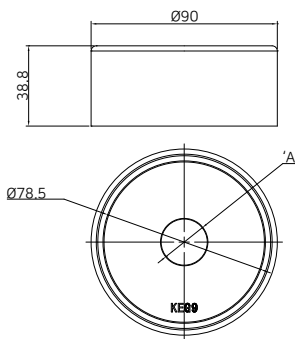

Model	'A'
KEG92	Ø22
KEG95	Ø25
KEG93	Ø30

HP119E / HP119K / HP119C / HP119E-R

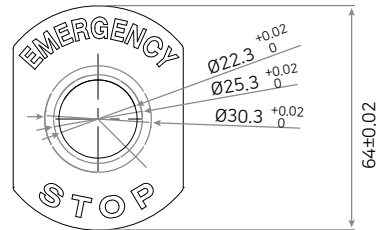

HP119E-1 시리즈

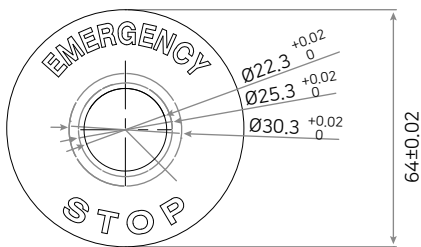

KEX-101Y

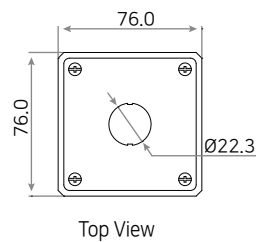

Top View

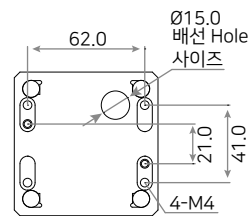
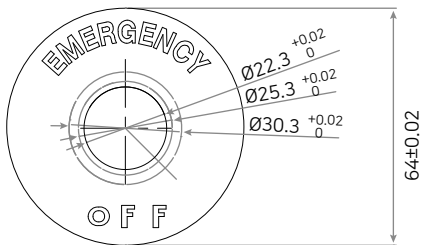

Bottom View

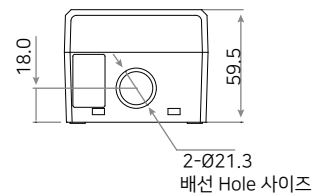

Side View

Ø16

Ø19

Ø20

외형치수도

단위 : mm

CBA / CBB

CBA2 / CBB2 / CBC

KT / 220VAC 트랜스

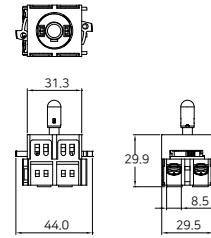
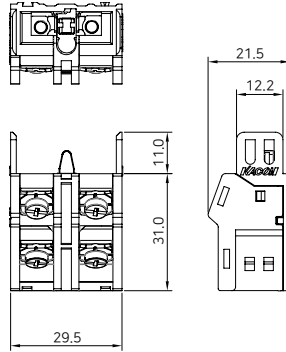
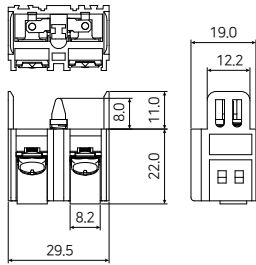

J2-10 / J2-01

J2-20 / J2-02 / J2-11

KAL / 자기유지 Holder

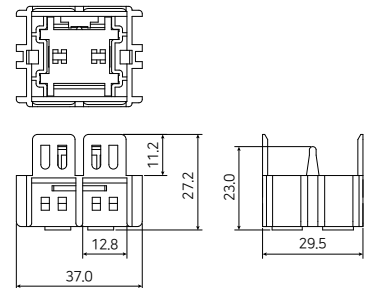
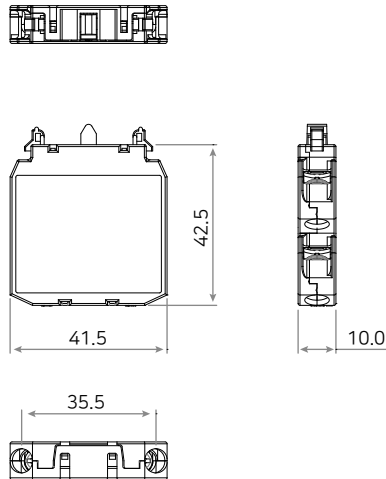
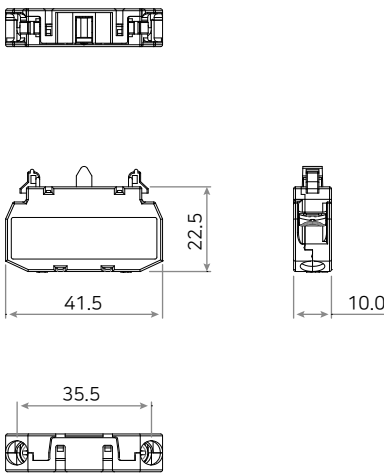

CBA, CBB용 접점안전커버

트랜스안전커버

CBA2 CBB2 CBC용 접점안전커버

KP-10

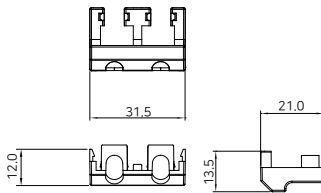

KP-20

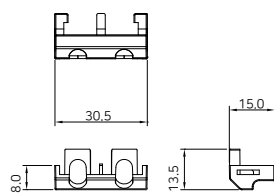

KP-30

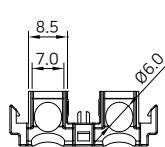

KP-31

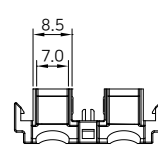

KP-11

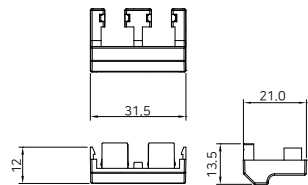

KP-21

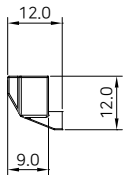
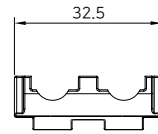
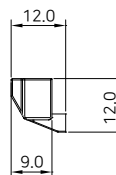
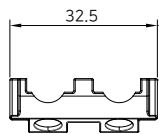
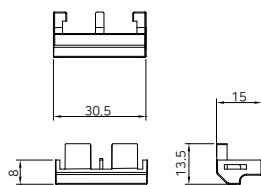

도면

제어용 스위치 약세서리

Ø22, 25, 30

외형치수도

단위 : mm

T16 커넥터

T19 커넥터

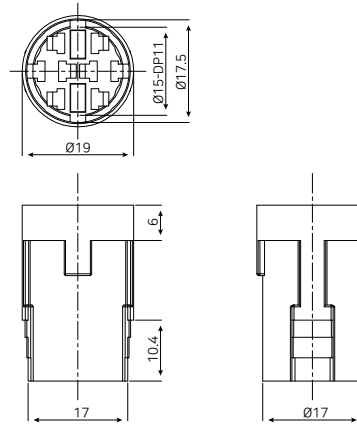
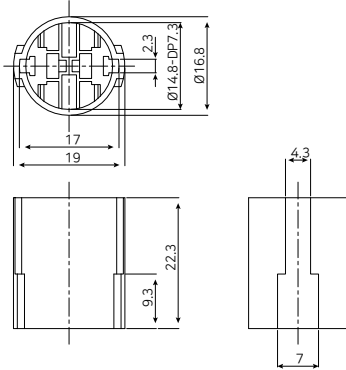

T22 커넥터

T25 커넥터

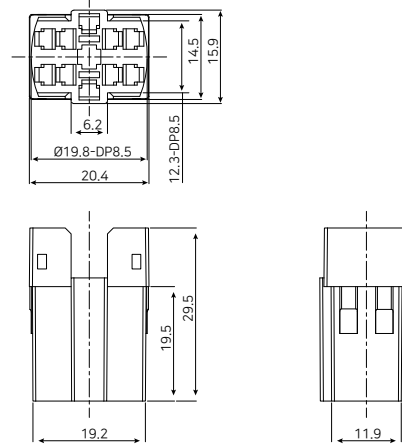
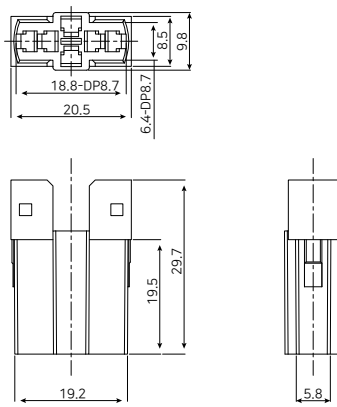

Ø16

Ø19

Ø20

패널 가공도 및 패널부착 간격 치수

KEG7 시리즈

KEG8, KEG9 시리즈

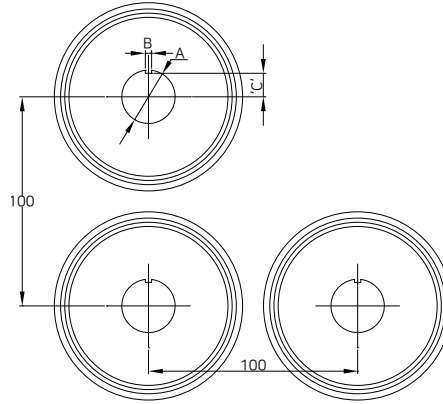
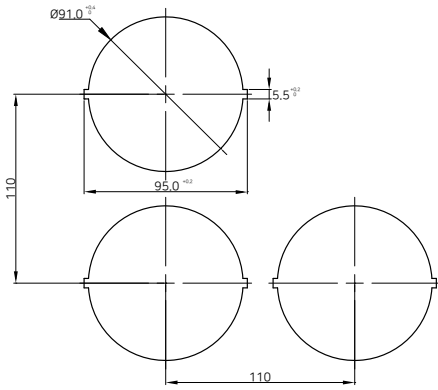

Model	'A'	'B'	'C'
KEG82, 92	Ø22.5	3	19.5
KEG85, 95	Ø25.5	3	22.5
KEG83, 93	Ø30.5	3	27.5

Ø22

Ø25

Ø30

도면