



적용 릴레이 사양

HR96A

접점사양	접점 구성	1N/O	
	접점 재질	Silver Alloy	
	최대접촉저항	100mΩ	
	정격전류(저항부하)	5A 30VDC	
		10A 125VAC	
		5A 250VAC	
	최대 접점용량	DC	150W
AC		1,250VA	
최소 스위칭 정격	100mA 5VDC		
코일사양	전압 사양	3VDC ~ 24VDC	
	소비전력	200mW 450mW	
	최소동작전압	정격 전압의 75% 이하	
	최대차단전압	정격 전압의 10% 이상	
동작시간	8ms		
차단시간	5ms		
절연저항	100MΩ min.(at 500VDC)		
내전압	접전과 코일간	4,000VAC 1분	
	접점간	1,000VAC 1분	
수명	기계적	최소 10,000,000	
	전기적	최소 100,000	
내진동	10Hz ~ 55Hz (진동폭 : 1.5mm)		
사용주위온도	-40°C ~ 70°C (무결빙)		
사용주위습도	35% ~ 85% RH		
무게	약 7g		
인증	UL, TUV		

ALQ324

접점사양	접점 구성	1N/O	
	접점 재질	Silver Alloy	
	초기 접촉 저항	100mΩ	
	스위칭 용량	10A 125VAC	
		5A 250VAC	
		5A 30VDC	
최대 스위칭	1,250VA, 150W		
최대 스위칭 전류	10A(125VAC), 5A(30VDC)		
절연저항	1,000MΩ min.(at 500VDC)		
일반사양	사용주위온도	-40°C ~ 85°C	
	사용주위습도	5% ~ 85% RH	
	무게	약 7g	
	인증	UL, VDE, CQC	

릴레이 터미널

RXT 시리즈

1 Part

릴레이 &
소켓

단상용
MC

릴레이
터미널















아날로그
타이머

SSR

온도
조절기

터치
스크린

제품구분도

	적용 릴레이	구분	품명
	 TF-1C 250VAC 6A 30VDC 6A	볼트 단자, 1P	RXT-F01
	 TF-1C 250VAC 6A 30VDC 6A	퀵단자, 1P	RXT-Q01
	 TA-1a 250VAC 5A 30VDC 5A (적용릴레이)	1P	RXT-A01
	 HR96A 250VAC 5A 30VDC 5A (적용릴레이)	1P	RXT-B01
	 TA-1a 250VAC 5A 30VDC 5A (적용릴레이)	4P	RXT-G04
	 APAN3124 250VAC 5A 30VDC 5A (적용릴레이)	4P	RXT-G04N
	 HR96A 250VAC 5A 30VDC 5A (적용릴레이)	4P	RXT-K04H
	 ALQ324 (PANASONIC) 125VAC 10A (적용릴레이)	4P	RXT-K04
	 TA-1a 250VAC 5A 30VDC 5A (적용릴레이)	NPN, 32P	RXT-N321
		PNP, 32P	RXT-P321

약세사리

	적용 품목	구분	품명
	RXT-F01 RXT-Q01	쇼트바	RXT-QS

Rev. 2/14

Data subject may change without notice.

www.kaicon.co.kr

Industrial Controls Catalog

I - 49

KAISON

외형치수도 및 회로도

단위 : mm

RXT - F01 스크류 타입

RXT - Q01 핀 타입

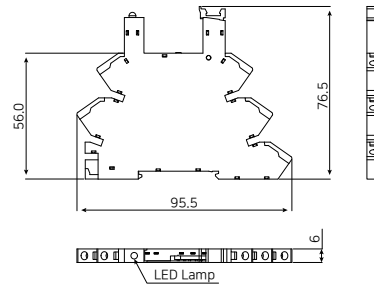
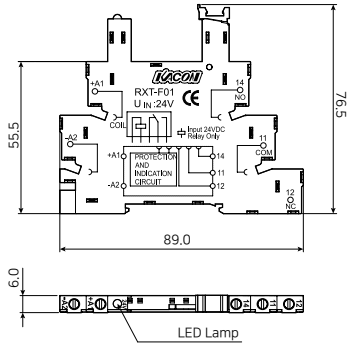

RXT - A01

RXT - B01

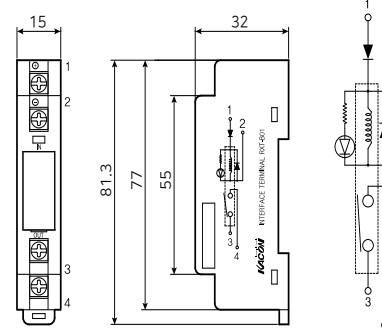
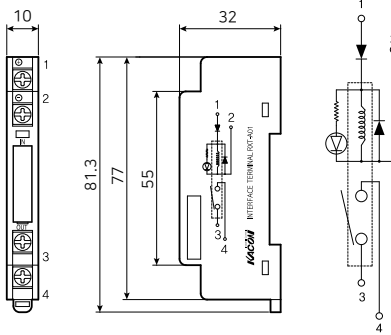

TF-1C

RXT-QS

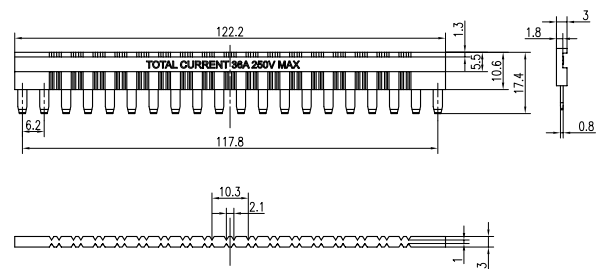
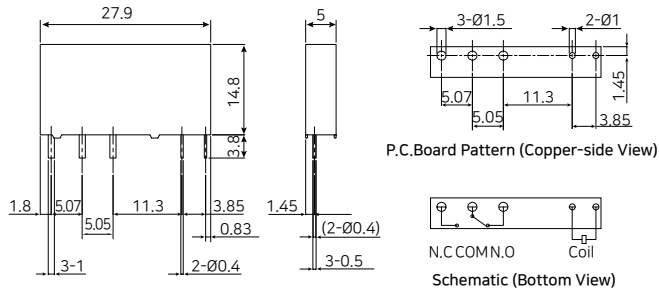

릴레이 터미널

RXT 시리즈

1 Part

릴레이 &
소켓

단상용
MC

릴레이
터미널

아날로그
타이머

SSR

온도
조절기

터치
스크린

외형치수도 및 회로도

단위 : mm

RXT - G04 (TA-1a 탑재)

RXT - G04N (APAN3124 탑재)

RXT - K04 (PANASONIC ALQ324-24V 탑재)

RXT - K04H (HR96A 탑재)

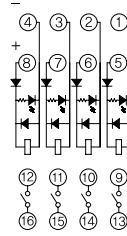
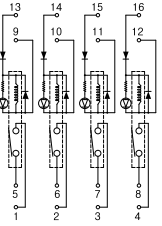
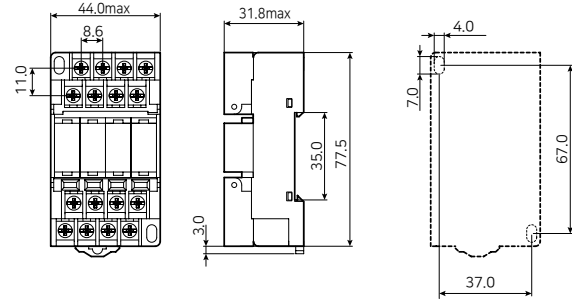
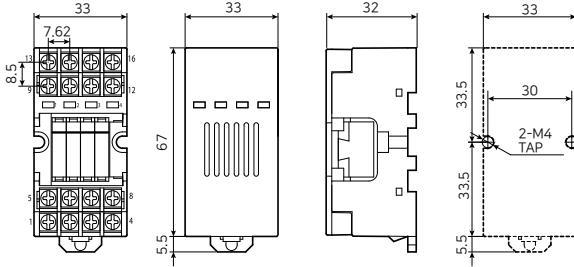

RXT - N32

